

SUITE LW-1

LIVE/WORK

INTERIOR 790 SQ. FT. | EXTERIOR 128 SQ. FT. | TOTAL 918 SQ. FT.

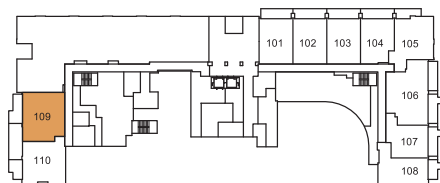
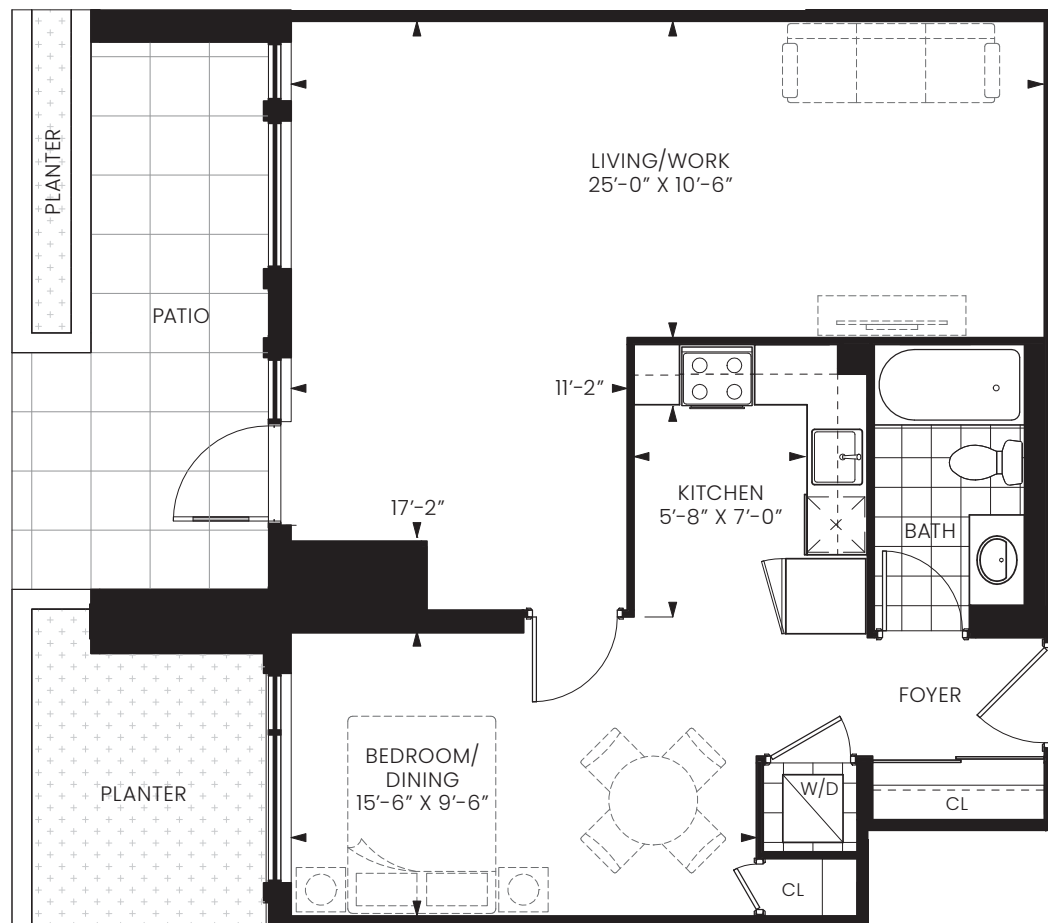

FLOOR 1

Note: All prices, figures, sizes, specifications and information, including without limitation the size, location, design and layout of windows, doors, walls, fixtures, closets, structures, appliances (if any), and the balcony are subject to change without notice to the Purchaser in order to comply with site conditions, municipal or governmental, structural, or architectural requirements, or for any reason at the discretion of the Vendor. Units on lower floors may have less floor space due to thicker structural members, mechanical rooms, etc. while units on higher floors may have more floor space. Bulkheads may not be shown on this plan and may be located in areas of the Unit as required for venting and mechanical systems. All areas and stated dimensions are approximate. Actual usable floor space, living area and square footage may vary from stated floor area. All illustrations are artist's concept only. Furniture is depicted for illustration purposes only & are not included. The unit shown may be the reverse of the unit purchased. The exact location of any balcony (if applicable) in relation to the unit layout may differ from that shown. E & O.E.



**CHESTNUT HILL
DEVELOPMENTS**

BUILDING COMMUNITIES SINCE 1981

SUITE LW-2

LIVE/WORK

INTERIOR 720 SQ. FT. | EXTERIOR 93 SQ. FT. | TOTAL 813 SQ. FT.

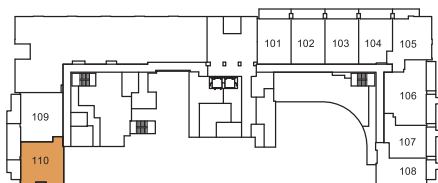
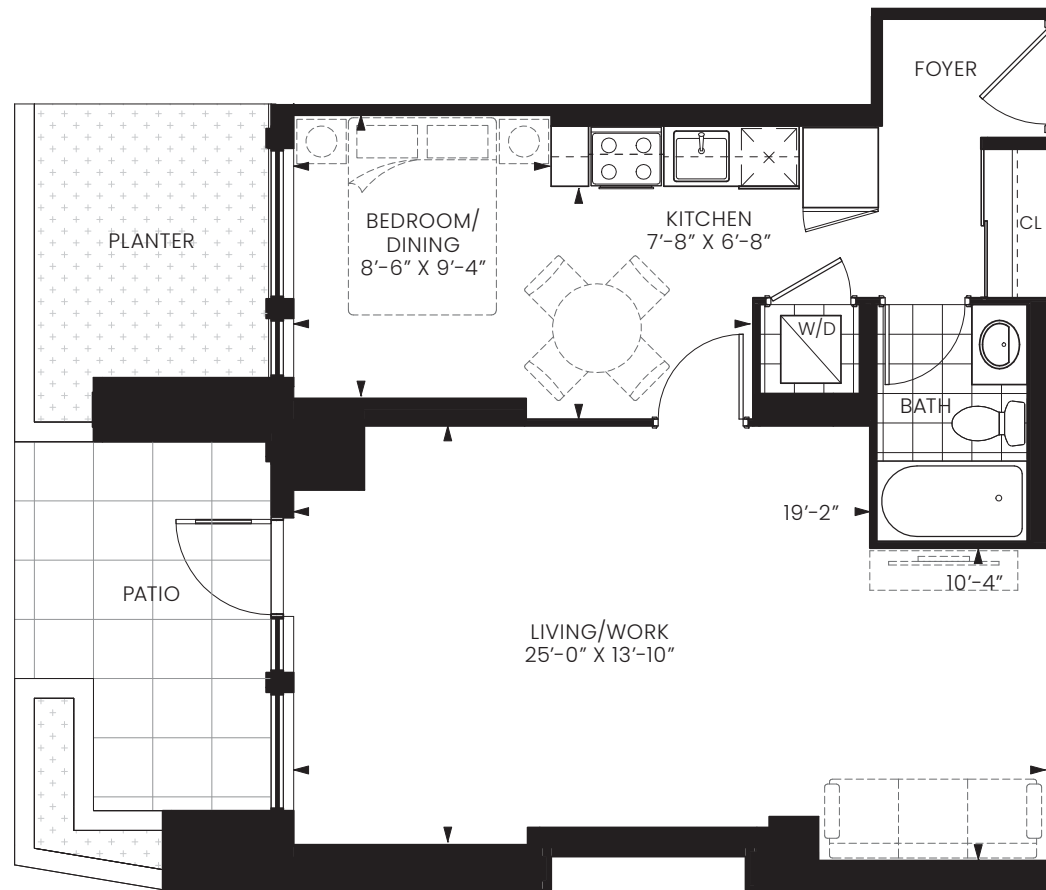

FLOOR 1

Note: All prices, figures, sizes, specifications and information, including without limitation the size, location, design and layout of windows, doors, walls, fixtures, closets, structures, appliances (if any), and the balcony are subject to change without notice to the Purchaser in order to comply with site conditions, municipal or governmental, structural, or architectural requirements, or for any reason at the discretion of the Vendor. Units on lower floors may have less floor space due to thicker structural members, mechanical rooms, etc. while units on higher floors may have more floor space. Bulkheads may not be shown on this plan and may be located in areas of the Unit as required for venting and mechanical systems. All areas and stated dimensions are approximate. Actual usable floor space, living area and square footage may vary from stated floor area. All illustrations are artist's concept only. Furniture is depicted for illustration purposes only & are not included. The unit shown may be the reverse of the unit purchased. The exact location of any balcony (if applicable) in relation to the unit layout may differ from that shown. E & O.E.



**CHESTNUT HILL
DEVELOPMENTS**

BUILDING COMMUNITIES SINCE 1981

SUITE 1A

ONE BEDROOM

INTERIOR 558 SQ. FT. | EXTERIOR 118 SQ. FT. | TOTAL 676 SQ. FT.

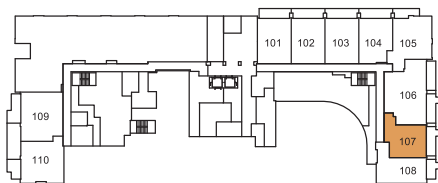
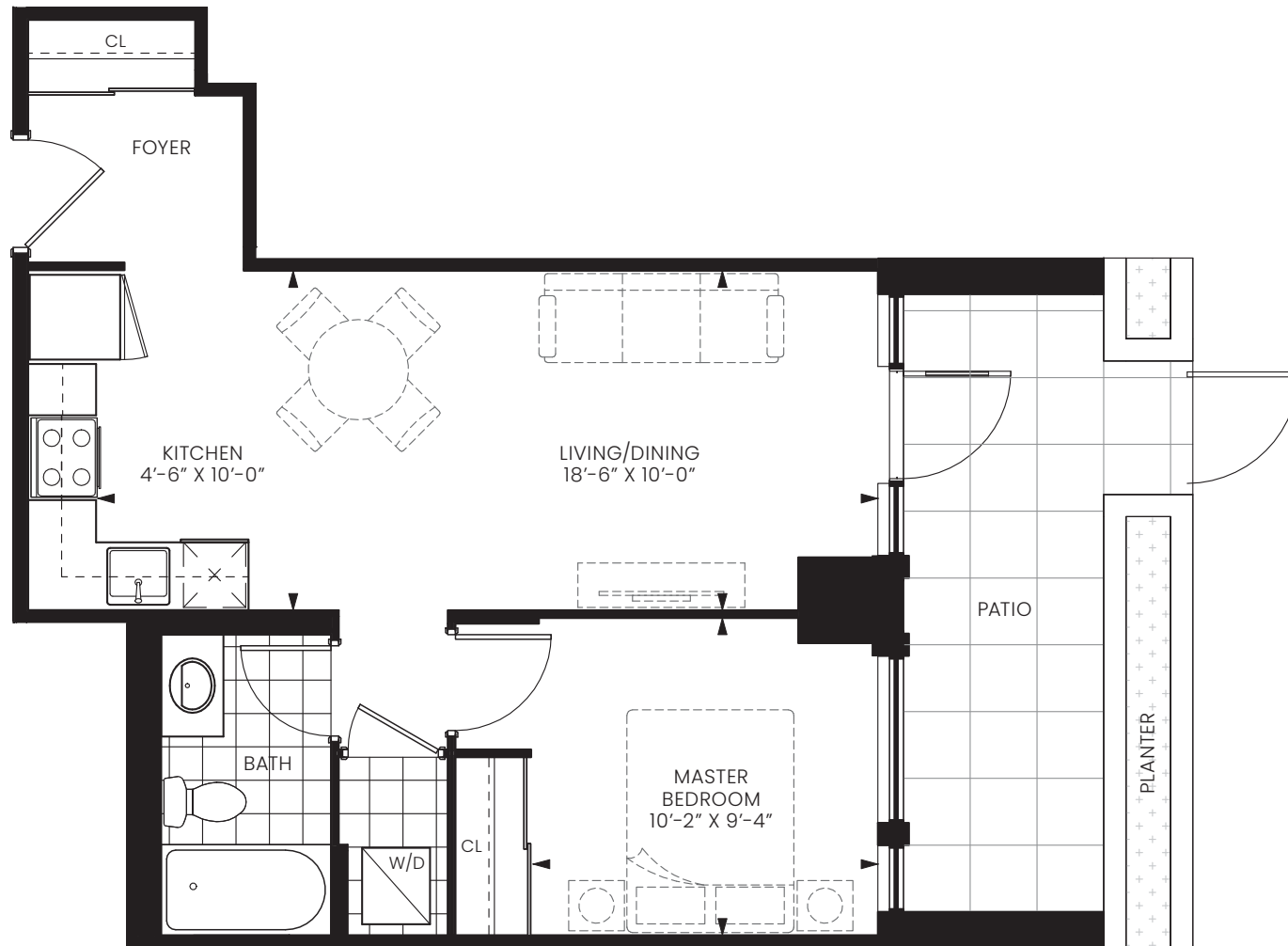

FLOOR 1

Note: All prices, figures, sizes, specifications and information, including without limitation the size, location, design and layout of windows, doors, walls, fixtures, closets, structures, appliances (if any), and the balcony are subject to change without notice to the Purchaser in order to comply with site conditions, municipal or governmental, structural, or architectural requirements, or for any reason at the discretion of the Vendor. Units on lower floors may have less floor space due to thicker structural members, mechanical rooms, etc. while units on higher floors may have more floor space. Bulkheads may not be shown on this plan and may be located in areas of the Unit as required for venting and mechanical systems. All areas and stated dimensions are approximate. Actual usable floor space, living area and square footage may vary from stated floor area. All illustrations are artist's concept only. Furniture is depicted for illustration purposes only & are not included. The unit shown may be the reverse of the unit purchased. The exact location of any balcony (if applicable) in relation to the unit layout may differ from that shown. E & O.E.



**CHESTNUT HILL
DEVELOPMENTS**

BUILDING COMMUNITIES SINCE 1981

SUITE 1B

ONE BEDROOM

INTERIOR 579 SQ. FT. | EXTERIOR 83 SQ. FT. | TOTAL 662 SQ. FT.

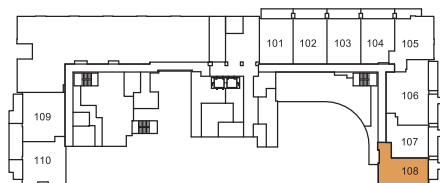
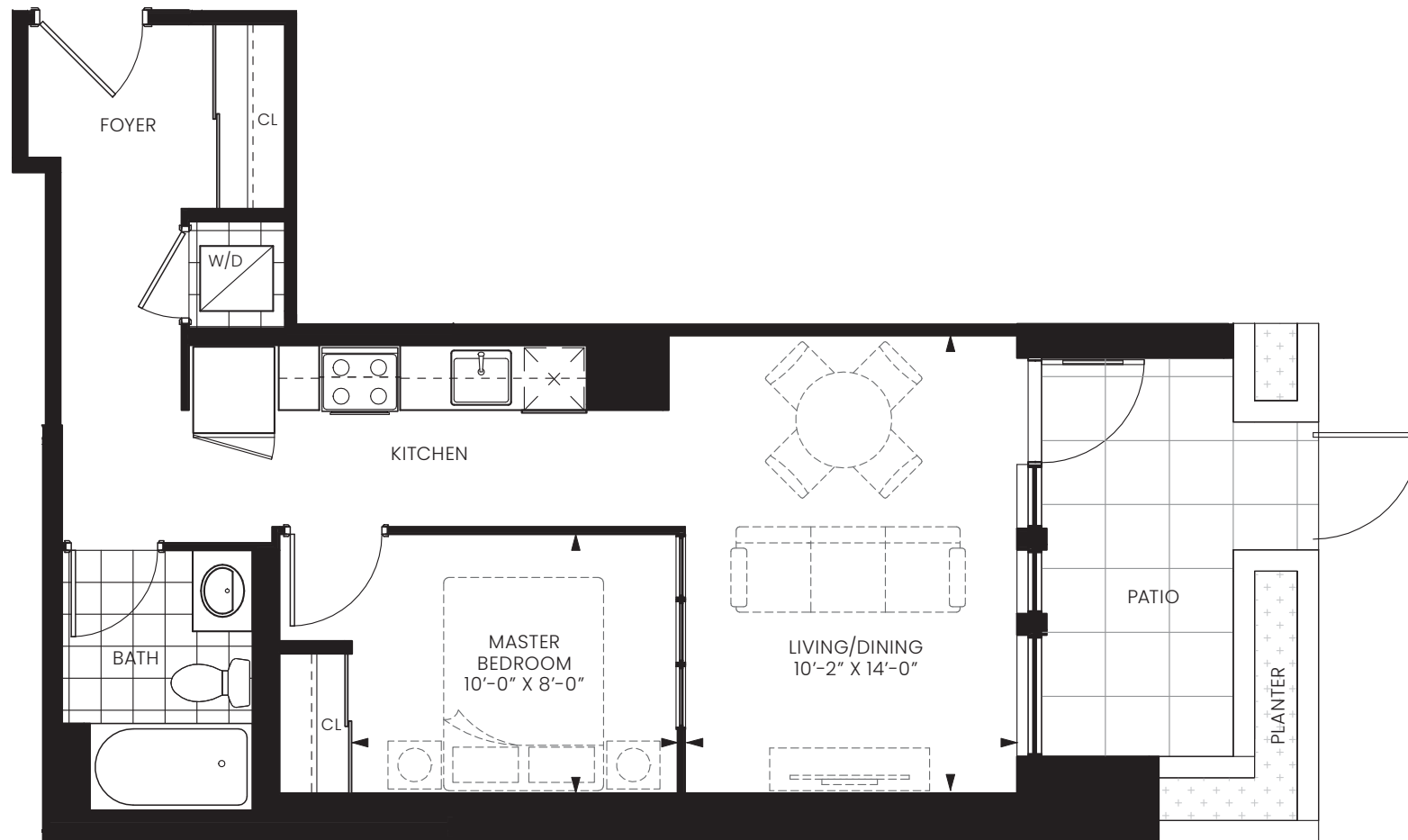

FLOOR 1

Note: All prices, figures, sizes, specifications and information, including without limitation the size, location, design and layout of windows, doors, walls, fixtures, closets, structures, appliances (if any), and the balcony are subject to change without notice to the Purchaser in order to comply with site conditions, municipal or governmental, structural, or architectural requirements, or for any reason at the discretion of the Vendor. Units on lower floors may have less floor space due to thicker structural members, mechanical rooms, etc. while units on higher floors may have more floor space. Bulkheads may not be shown on this plan and may be located in areas of the Unit as required for venting and mechanical systems. All areas and stated dimensions are approximate. Actual usable floor space, living area and square footage may vary from stated floor area. All illustrations are artist's concept only. Furniture is depicted for illustration purposes only & are not included. The unit shown may be the reverse of the unit purchased. The exact location of any balcony (if applicable) in relation to the unit layout may differ from that shown. E & O.E.



**CHESTNUT HILL
DEVELOPMENTS**

BUILDING COMMUNITIES SINCE 1981

SUITE 1A + D

ONE BEDROOM + DEN

INTERIOR 597 SQ. FT. | EXTERIOR 123 SQ. FT. (SUITE 101 - 123 SQ. FT.) | TOTAL 720 SQ. FT.

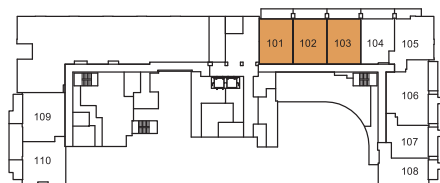
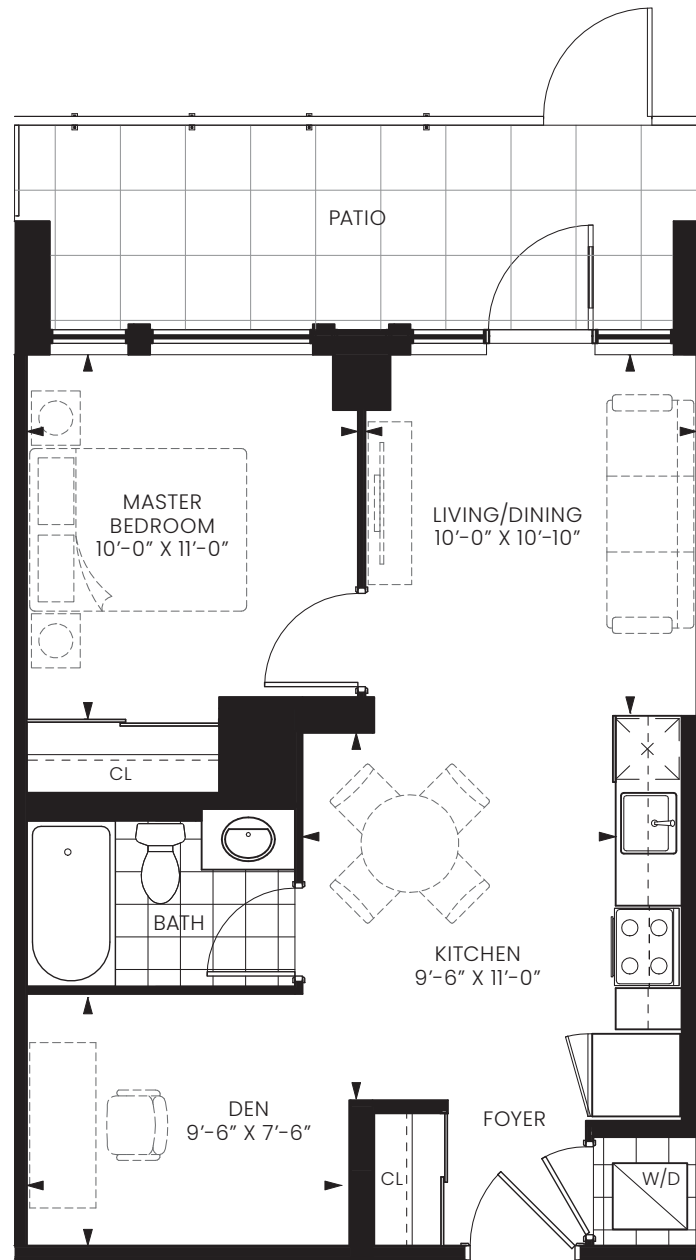

FLOOR 1

Note: All prices, figures, sizes, specifications and information, including without limitation the size, location, design and layout of windows, doors, walls, fixtures, closets, structures, appliances (if any), and the balcony are subject to change without notice to the Purchaser in order to comply with site conditions, municipal or governmental, structural, or architectural requirements, or for any reason at the discretion of the Vendor. Units on lower floors may have less floor space due to thicker structural members, mechanical rooms, etc. while units on higher floors may have more floor space. Bulkheads may not be shown on this plan and may be located in areas of the Unit as required for venting and mechanical systems. All areas and stated dimensions are approximate. Actual usable floor space, living area and square footage may vary from stated floor area. All illustrations are artist's concept only. Furniture is depicted for illustration purposes only & are not included. The unit shown may be the reverse of the unit purchased. The exact location of any balcony (if applicable) in relation to the unit layout may differ from that shown. E & O.E.



**CHESTNUT HILL
DEVELOPMENTS**

BUILDING COMMUNITIES SINCE 1981

SUITE 1B+D

ONE BEDROOM + DEN

INTERIOR 762 SQ. FT. | EXTERIOR 43 SQ. FT. | TOTAL 805 SQ. FT.

EXTERIOR AT 6TH & 7TH 87 SQ. FT. | EXTERIOR AT 3RD 183 SQ. FT. | EXTERIOR AT 2ND 139 SQ. FT.

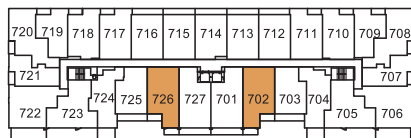
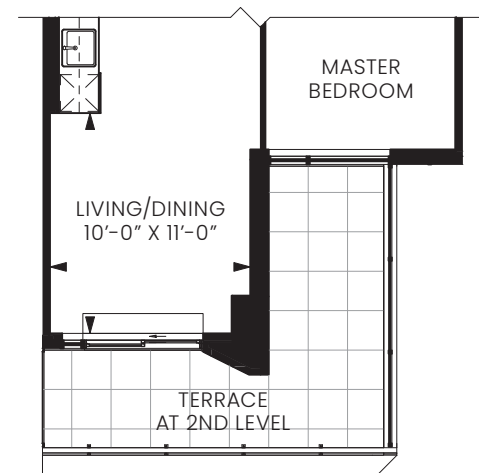
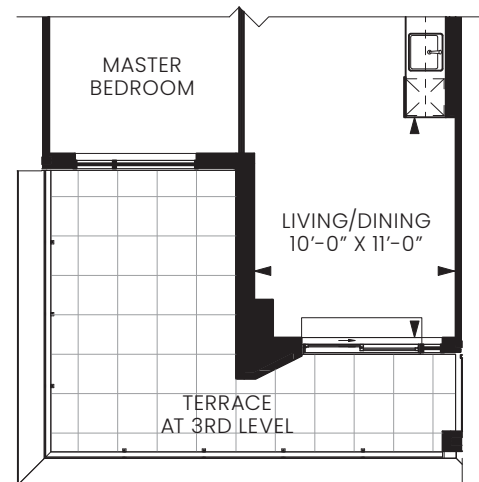
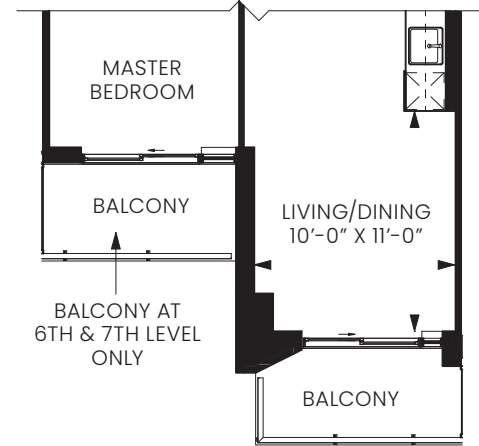
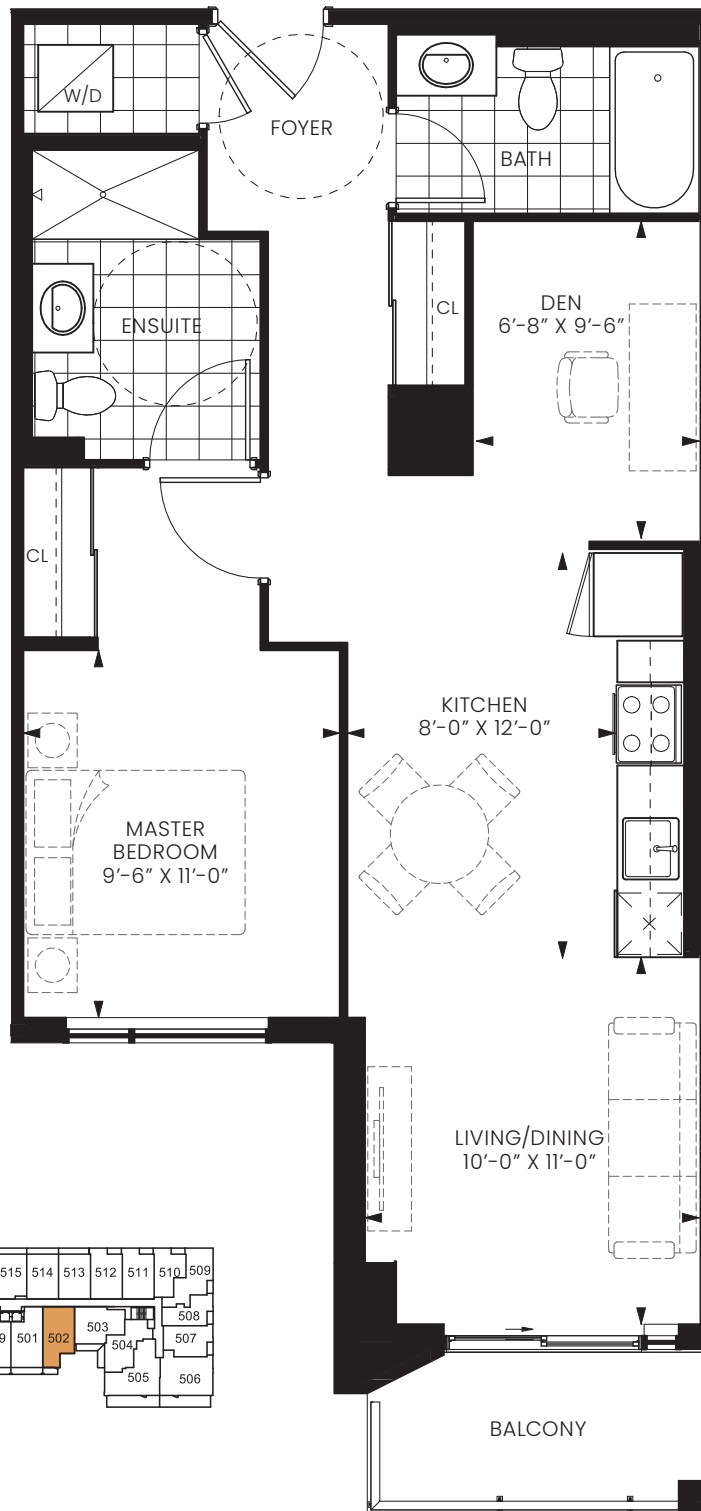

FLOOR 7



FLOOR 6



FLOOR 4

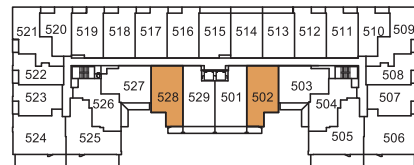

FLOOR 5



FLOOR 2



FLOOR 3

Note: All prices, figures, sizes, specifications and information, including without limitation the size, location, design and layout of windows, doors, walls, fixtures, closets, structures, appliances (if any), and the balcony are subject to change without notice to the Purchaser in order to comply with site conditions, municipal or governmental, structural, or architectural requirements, or for any reason at the discretion of the Vendor. Units on lower floors may have less floor space due to thicker structural members, mechanical rooms, etc. while units on higher floors may have more floor space. Bulkheads may not be shown on this plan and may be located in areas of the Unit as required for venting and mechanical systems. All areas and stated dimensions are approximate. Actual usable floor space, living area and square footage may vary from stated floor area. All illustrations are artist's concept only. Furniture is depicted for illustration purposes only & are not included. The unit shown may be the reverse of the unit purchased. The exact location of any balcony (if applicable) in relation to the unit layout may differ from that shown. E & O.E.



CHESTNUT HILL DEVELOPMENTS

BUILDING COMMUNITIES SINCE 1981

SUITE 1C+D

ONE BEDROOM + DEN

INTERIOR 773 SQ. FT. | EXTERIOR 47 SQ. FT. | TOTAL 820 SQ. FT.

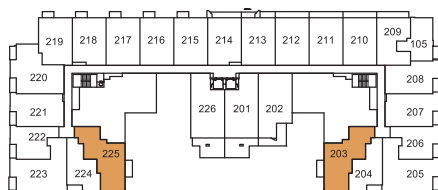
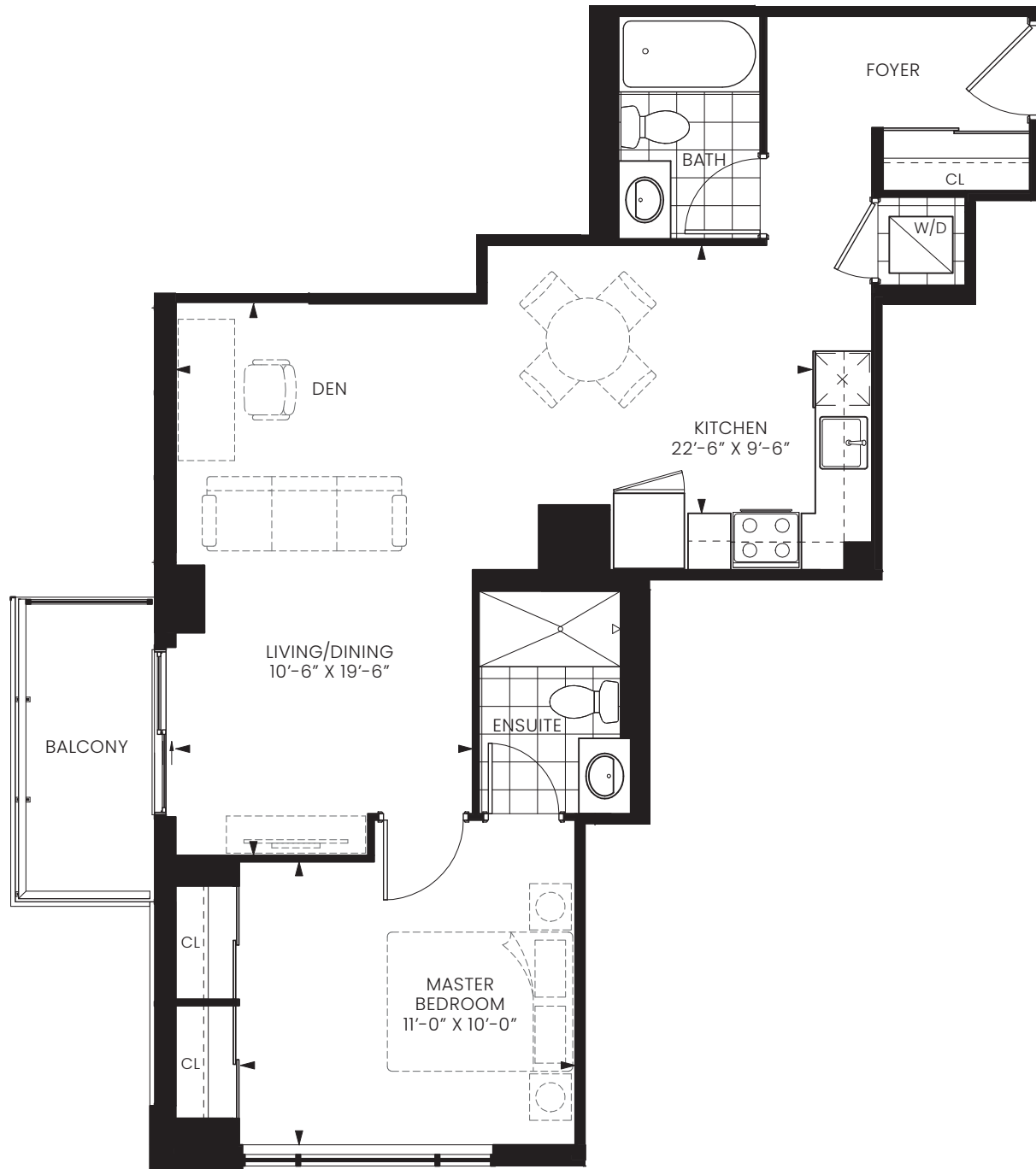

FLOOR 2

Note: All prices, figures, sizes, specifications and information, including without limitation the size, location, design and layout of windows, doors, walls, fixtures, closets, structures, appliances (if any), and the balcony are subject to change without notice to the Purchaser in order to comply with site conditions, municipal or governmental, structural, or architectural requirements, or for any reason at the discretion of the Vendor. Units on lower floors may have less floor space due to thicker structural members, mechanical rooms, etc. while units on higher floors may have more floor space. Bulkheads may not be shown on this plan and may be located in areas of the Unit as required for venting and mechanical systems. All areas and stated dimensions are approximate. Actual usable floor space, living area and square footage may vary from stated floor area. All illustrations are artist's concept only. Furniture is depicted for illustration purposes only & are not included. The unit shown may be the reverse of the unit purchased. The exact location of any balcony (if applicable) in relation to the unit layout may differ from that shown. E & O.E.



**CHESTNUT HILL
DEVELOPMENTS**

BUILDING COMMUNITIES SINCE 1981

SUITE 1D + D

ONE BEDROOM + DEN

INTERIOR 652 SQ. FT. | EXTERIOR 34 SQ. FT. | TOTAL 686 SQ. FT.

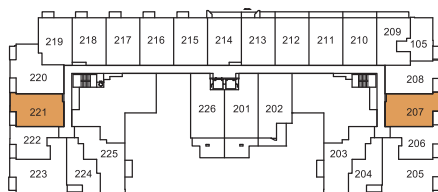
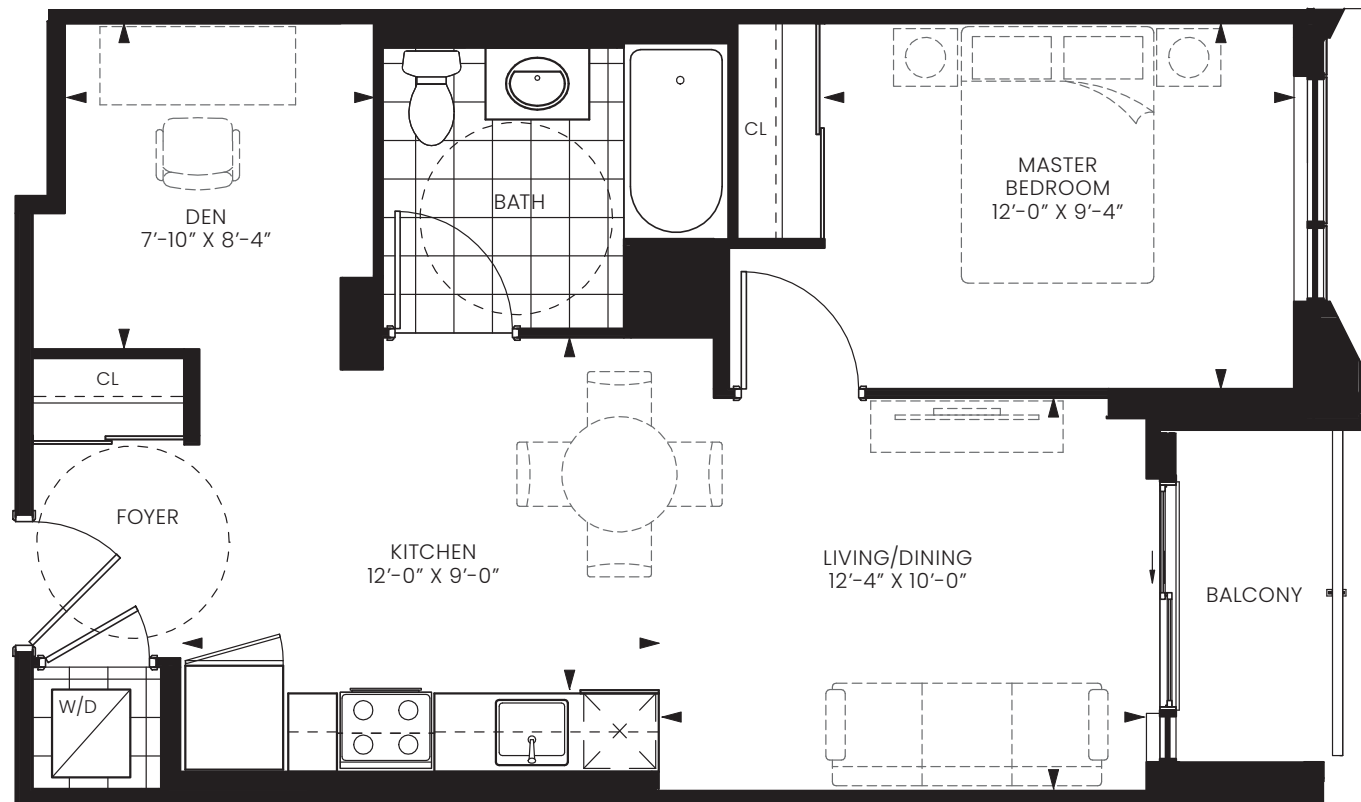

FLOOR 2

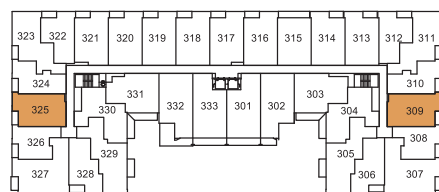

FLOOR 3

Note: All prices, figures, sizes, specifications and information, including without limitation the size, location, design and layout of windows, doors, walls, fixtures, closets, structures, appliances (if any), and the balcony are subject to change without notice to the Purchaser in order to comply with site conditions, municipal or governmental, structural, or architectural requirements, or for any reason at the discretion of the Vendor. Units on lower floors may have less floor space due to thicker structural members, mechanical rooms, etc. while units on higher floors may have more floor space. Bulkheads may not be shown on this plan and may be located in areas of the Unit as required for venting and mechanical systems. All areas and stated dimensions are approximate. Actual usable floor space, living area and square footage may vary from stated floor area. All illustrations are artist's concept only. Furniture is depicted for illustration purposes only & are not included. The unit shown may be the reverse of the unit purchased. The exact location of any balcony (if applicable) in relation to the unit layout may differ from that shown. E & O.E.



**CHESTNUT HILL
DEVELOPMENTS**

BUILDING COMMUNITIES SINCE 1981

SUITE 1F + D

ONE BEDROOM + DEN

INTERIOR 628 SQ. FT. | EXTERIOR 84 SQ. FT. | TOTAL 712 SQ. FT.

EXTERIOR AT 2ND 27 SQ. FT. | EXTERIOR AT 2ND 65 SQ. FT. | EXTERIOR AT 4TH, 6TH & 7TH 81 SQ. FT.

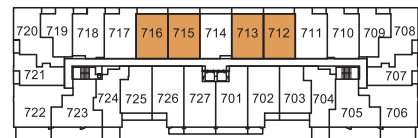
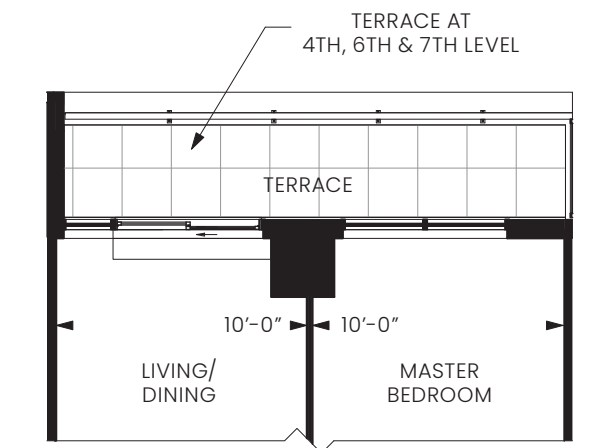
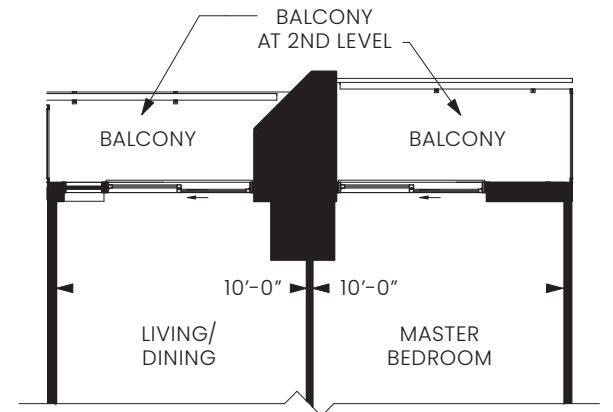
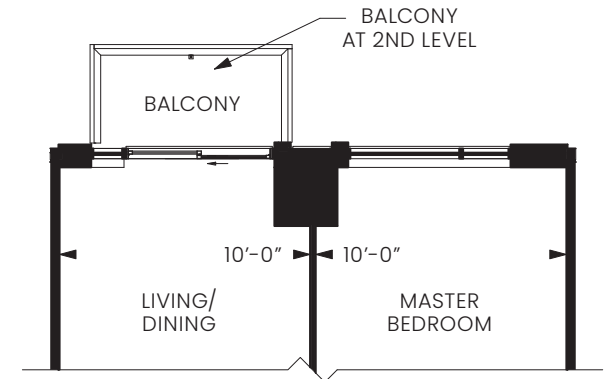
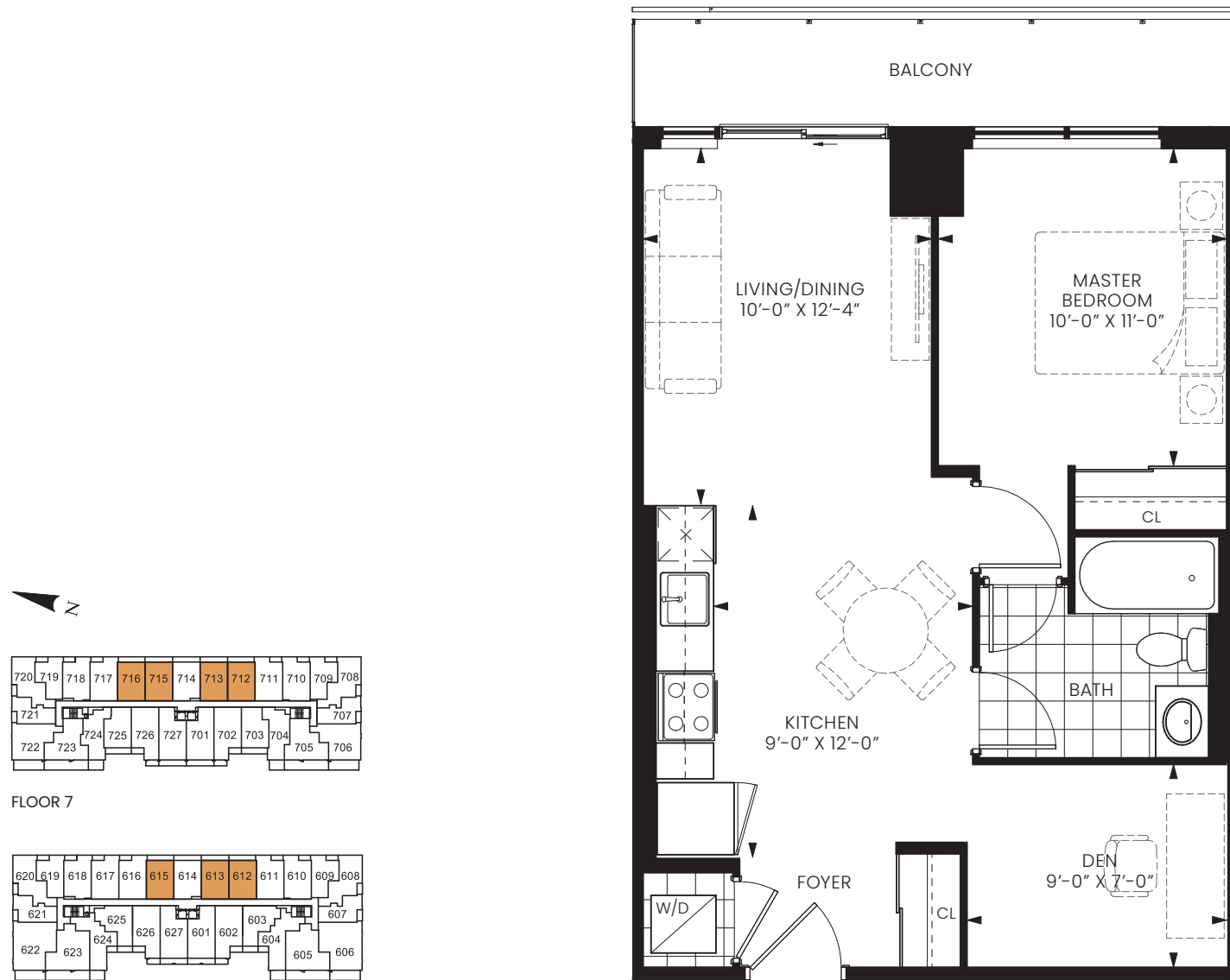

FLOOR 7



FLOOR 6



FLOOR 4



FLOOR 5

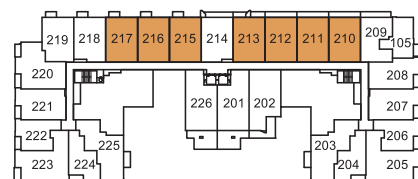

FLOOR 2



FLOOR 3

Note: All prices, figures, sizes, specifications and information, including without limitation the size, location, design and layout of windows, doors, walls, fixtures, closets, structures, appliances (if any), and the balcony are subject to change without notice to the Purchaser in order to comply with site conditions, municipal or governmental, structural, or architectural requirements, or for any reason at the discretion of the Vendor. Units on lower floors may have less floor space due to thicker structural members, mechanical rooms, etc. while units on higher floors may have more floor space. Bulkheads may not be shown on this plan and may be located in areas of the Unit as required for venting and mechanical systems. All areas and stated dimensions are approximate. Actual usable floor space, living area and square footage may vary from stated floor area. All illustrations are artist's concept only. Furniture is depicted for illustration purposes only & are not included. The unit shown may be the reverse of the unit purchased. The exact location of any balcony (if applicable) in relation to the unit layout may differ from that shown. E & O.E.



CHESTNUT HILL DEVELOPMENTS

BUILDING COMMUNITIES SINCE 1981

SUITE 1K + D

ONE BEDROOM + DEN

INTERIOR 726 SQ. FT. | EXTERIOR 75 SQ. FT. | TOTAL 801 SQ. FT.

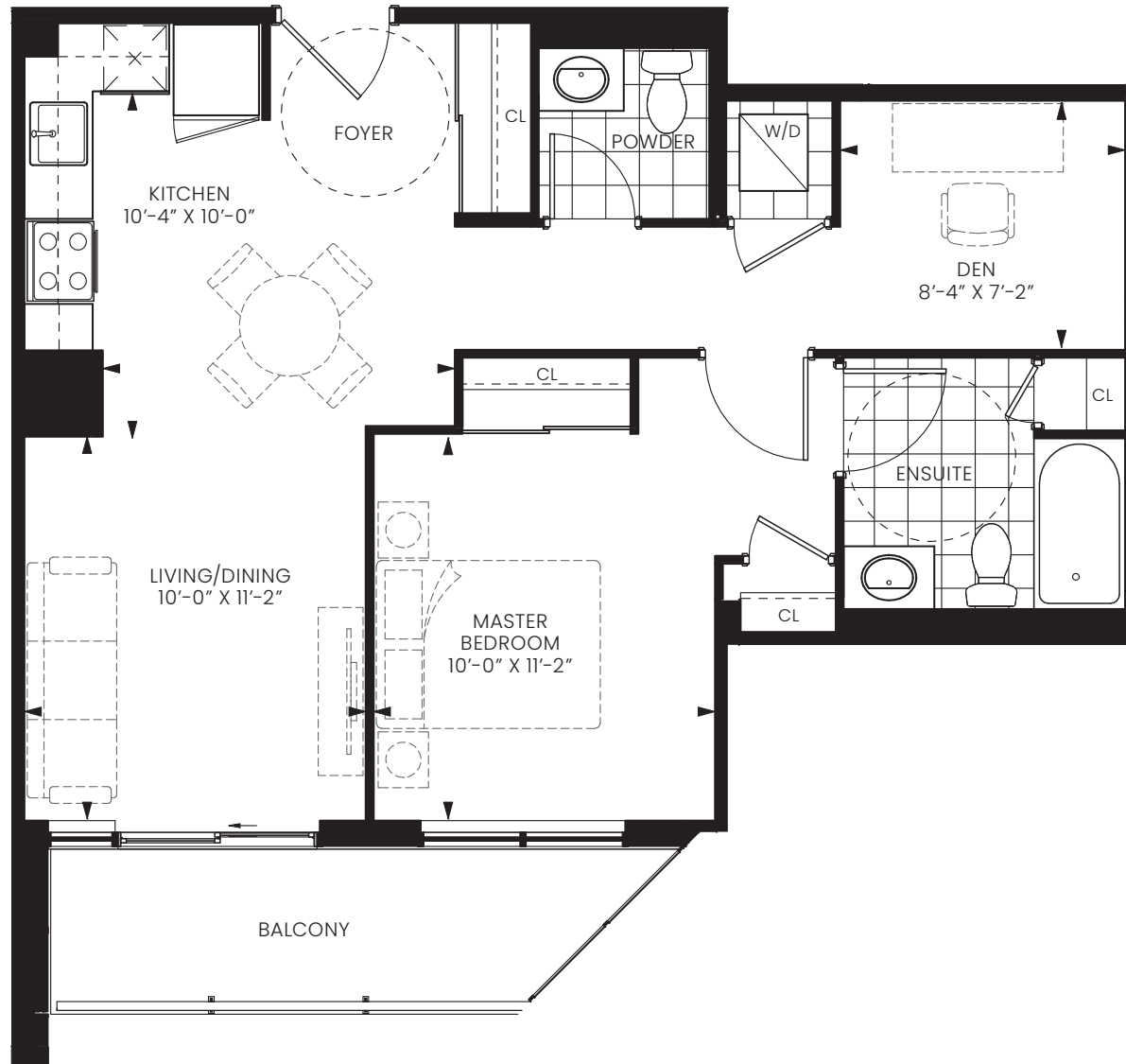

FLOOR 3



FLOOR 4



FLOOR 5

Note: All prices, figures, sizes, specifications and information, including without limitation the size, location, design and layout of windows, doors, walls, fixtures, closets, structures, appliances (if any), and the balcony are subject to change without notice to the Purchaser in order to comply with site conditions, municipal or governmental, structural, or architectural requirements, or for any reason at the discretion of the Vendor. Units on lower floors may have less floor space due to thicker structural members, mechanical rooms, etc. while units on higher floors may have more floor space. Bulkheads may not be shown on this plan and may be located in areas of the Unit as required for venting and mechanical systems. All areas and stated dimensions are approximate. Actual usable floor space, living area and square footage may vary from stated floor area. All illustrations are artist's concept only. Furniture is depicted for illustration purposes only & are not included. The unit shown may be the reverse of the unit purchased. The exact location of any balcony (if applicable) in relation to the unit layout may differ from that shown. E & O.E.



**CHESTNUT HILL
DEVELOPMENTS**

BUILDING COMMUNITIES SINCE 1981

SUITE 1L + D

ONE BEDROOM + DEN

INTERIOR 692 SQ. FT. | EXTERIOR 62 SQ. FT. | TOTAL 754 SQ. FT.

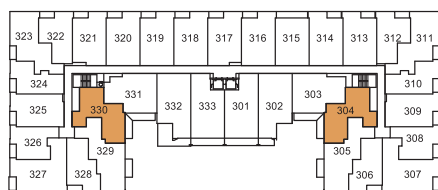
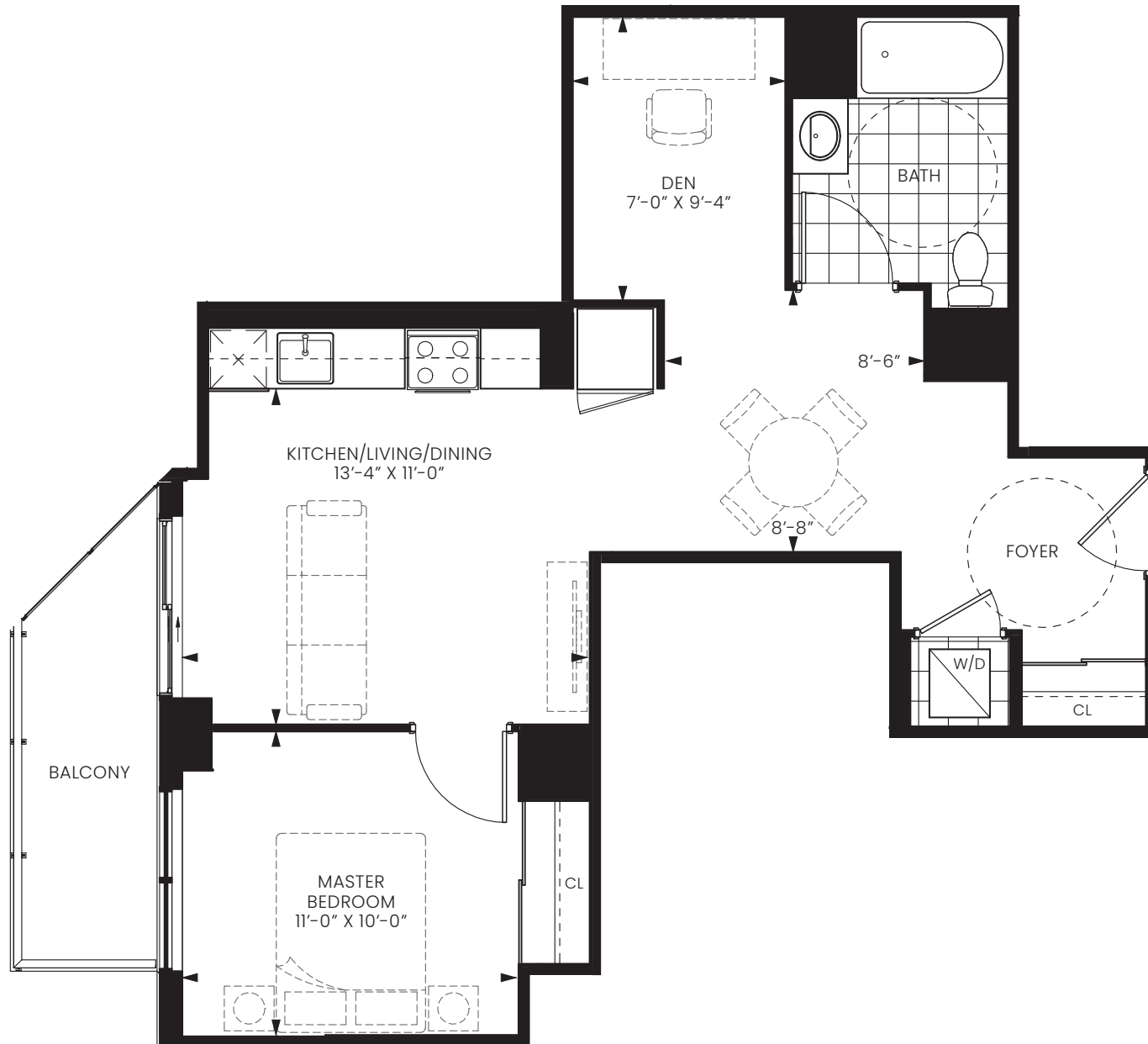

FLOOR 3

Note: All prices, figures, sizes, specifications and information, including without limitation the size, location, design and layout of windows, doors, walls, fixtures, closets, structures, appliances (if any), and the balcony are subject to change without notice to the Purchaser in order to comply with site conditions, municipal or governmental, structural, or architectural requirements, or for any reason at the discretion of the Vendor. Units on lower floors may have less floor space due to thicker structural members, mechanical rooms, etc. while units on higher floors may have more floor space. Bulkheads may not be shown on this plan and may be located in areas of the Unit as required for venting and mechanical systems. All areas and stated dimensions are approximate. Actual usable floor space, living area and square footage may vary from stated floor area. All illustrations are artist's concept only. Furniture is depicted for illustration purposes only & are not included. The unit shown may be the reverse of the unit purchased. The exact location of any balcony (if applicable) in relation to the unit layout may differ from that shown. E & O.E.



**CHESTNUT HILL
DEVELOPMENTS**

BUILDING COMMUNITIES SINCE 1981

SUITE 1M + D

ONE BEDROOM + DEN

INTERIOR 786 SQ. FT. | EXTERIOR 51 SQ. FT. | TOTAL 837 SQ. FT.

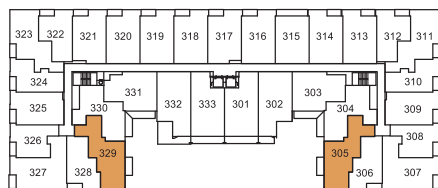
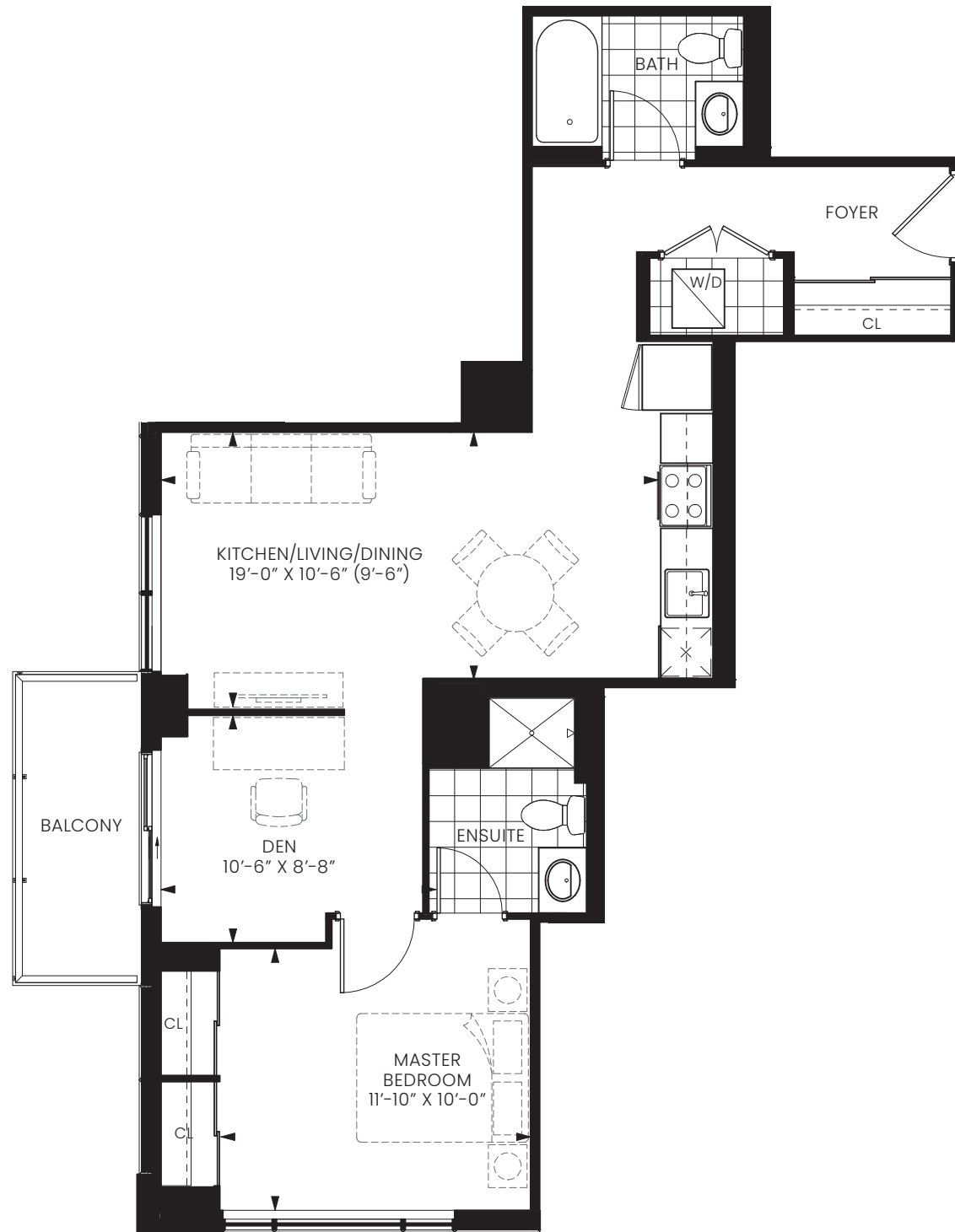

FLOOR 3

Note: All prices, figures, sizes, specifications and information, including without limitation the size, location, design and layout of windows, doors, walls, fixtures, closets, structures, appliances (if any), and the balcony are subject to change without notice to the Purchaser in order to comply with site conditions, municipal or governmental, structural, or architectural requirements, or for any reason at the discretion of the Vendor. Units on lower floors may have less floor space due to thicker structural members, mechanical rooms, etc. while units on higher floors may have more floor space. Bulkheads may not be shown on this plan and may be located in areas of the Unit as required for venting and mechanical systems. All areas and stated dimensions are approximate. Actual usable floor space, living area and square footage may vary from stated floor area. All illustrations are artist's concept only. Furniture is depicted for illustration purposes only & are not included. The unit shown may be the reverse of the unit purchased. The exact location of any balcony (if applicable) in relation to the unit layout may differ from that shown. E & O.E.



**CHESTNUT HILL
DEVELOPMENTS**

BUILDING COMMUNITIES SINCE 1981

SUITE 1P+D

ONE BEDROOM + DEN

INTERIOR 675 SQ. FT. | EXTERIOR 37 SQ. FT. | TOTAL 712 SQ. FT.

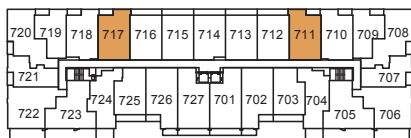
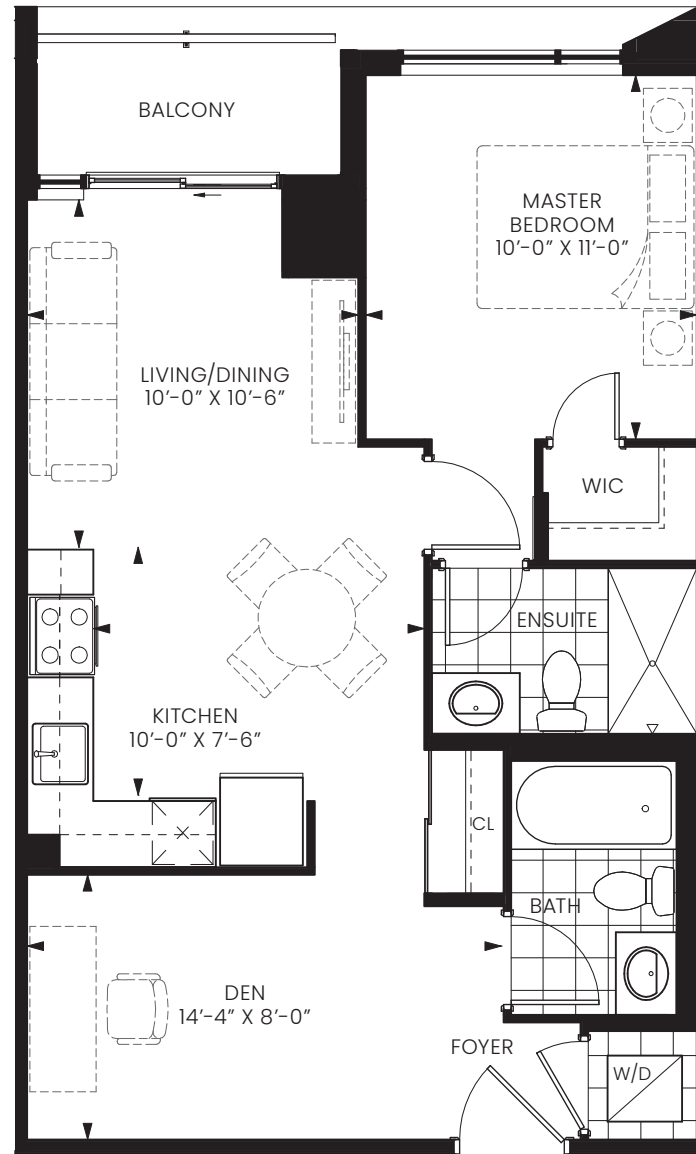

FLOOR 7

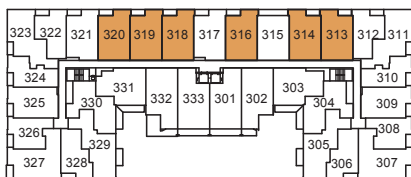

FLOOR 3



FLOOR 4



FLOOR 5

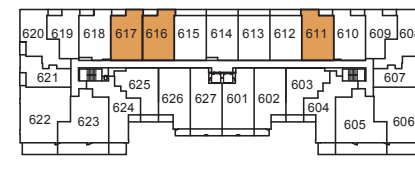

FLOOR 6

Note: All prices, figures, sizes, specifications and information, including without limitation the size, location, design and layout of windows, doors, walls, fixtures, closets, structures, appliances (if any), and the balcony are subject to change without notice to the Purchaser in order to comply with site conditions, municipal or governmental, structural, or architectural requirements, or for any reason at the discretion of the Vendor. Units on lower floors may have less floor space due to thicker structural members, mechanical rooms, etc. while units on higher floors may have more floor space. Bulkheads may not be shown on this plan and may be located in areas of the Unit as required for venting and mechanical systems. All areas and stated dimensions are approximate. Actual usable floor space, living area and square footage may vary from stated floor area. All illustrations are artist's concept only. Furniture is depicted for illustration purposes only & are not included. The unit shown may be the reverse of the unit purchased. The exact location of any balcony (if applicable) in relation to the unit layout may differ from that shown. E. & O.E.



**CHESTNUT HILL
DEVELOPMENTS**

BUILDING COMMUNITIES SINCE 1981

SUITE 1Q+D

ONE BEDROOM + DEN

INTERIOR 660 SQ. FT. | EXTERIOR 37 SQ. FT. | TOTAL 697 SQ. FT.

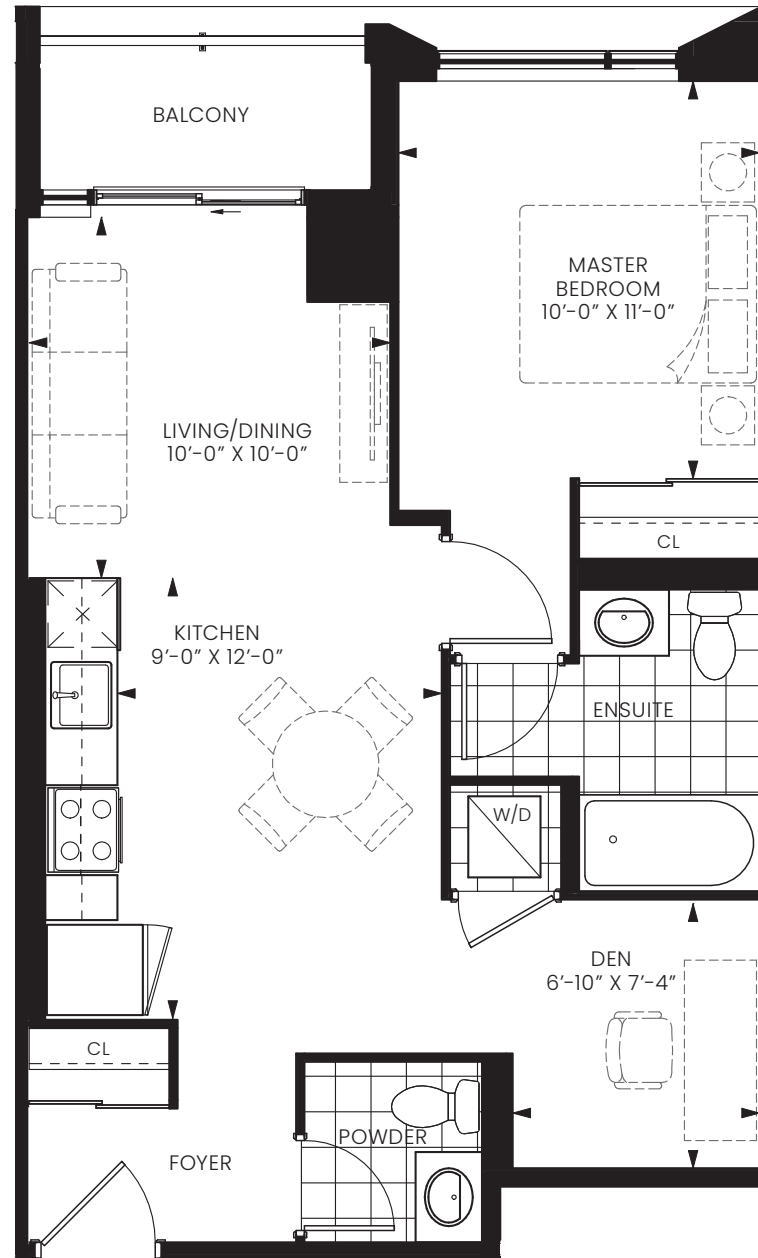

FLOOR 3



FLOOR 4

Note: All prices, figures, sizes, specifications and information, including without limitation the size, location, design and layout of windows, doors, walls, fixtures, closets, structures, appliances (if any), and the balcony are subject to change without notice to the Purchaser in order to comply with site conditions, municipal or governmental, structural, or architectural requirements, or for any reason at the discretion of the Vendor. Units on lower floors may have less floor space due to thicker structural members, mechanical rooms, etc. while units on higher floors may have more floor space. Bulkheads may not be shown on this plan and may be located in areas of the Unit as required for venting and mechanical systems. All areas and stated dimensions are approximate. Actual usable floor space, living area and square footage may vary from stated floor area. All illustrations are artist's concept only. Furniture is depicted for illustration purposes only & are not included. The unit shown may be the reverse of the unit purchased. The exact location of any balcony (if applicable) in relation to the unit layout may differ from that shown. E & O.E.



**CHESTNUT HILL
DEVELOPMENTS**

BUILDING COMMUNITIES SINCE 1981

SUITE 1S+D

ONE BEDROOM + DEN

INTERIOR 710 SQ. FT. | EXTERIOR 75 SQ. FT. | TOTAL 785 SQ. FT.

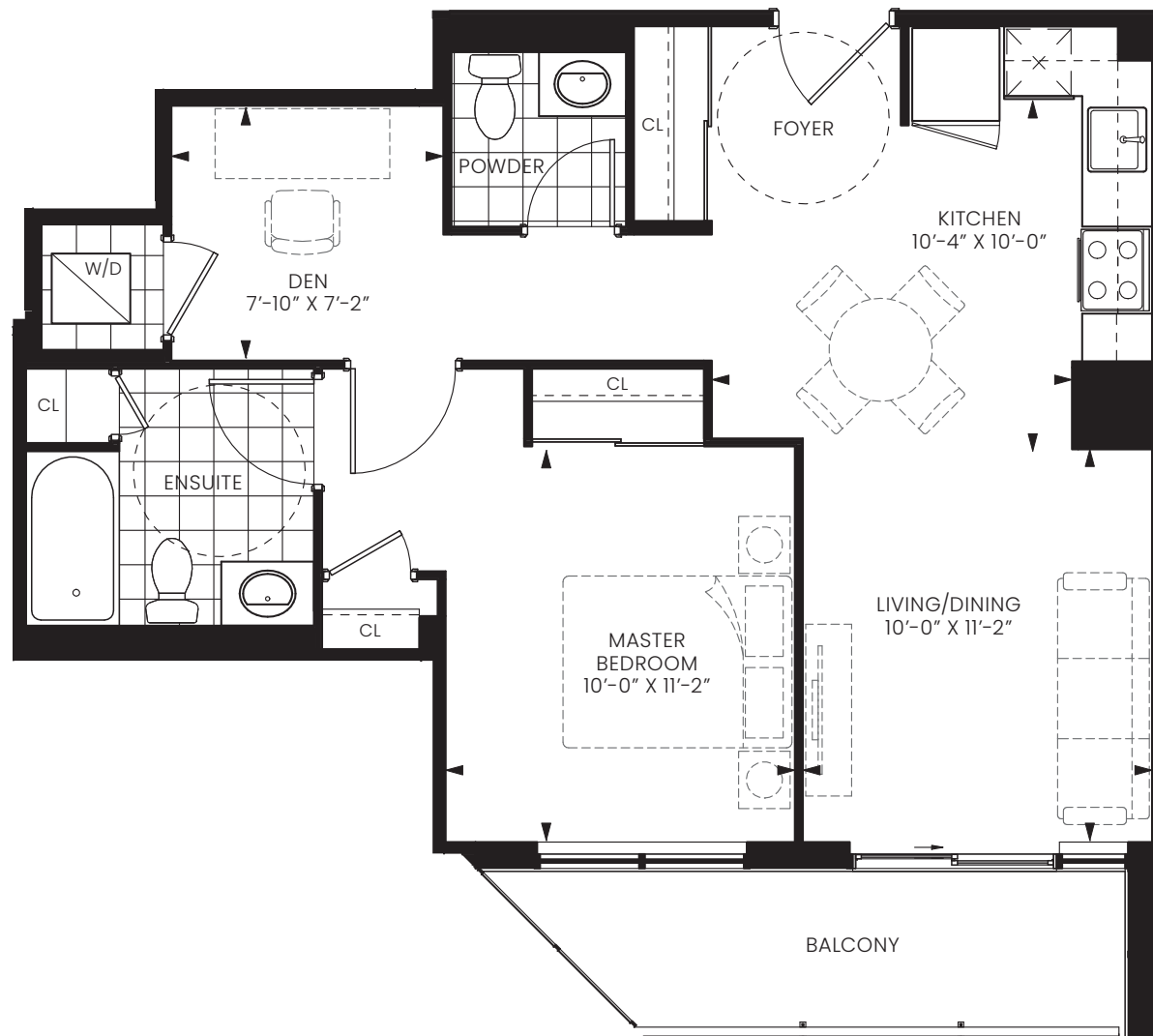

FLOOR 3



FLOOR 4

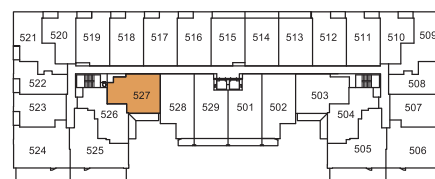

FLOOR 5

Note: All prices, figures, sizes, specifications and information, including without limitation the size, location, design and layout of windows, doors, walls, fixtures, closets, structures, appliances (if any), and the balcony are subject to change without notice to the Purchaser in order to comply with site conditions, municipal or governmental, structural, or architectural requirements, or for any reason at the discretion of the Vendor. Units on lower floors may have less floor space due to thicker structural members, mechanical rooms, etc. while units on higher floors may have more floor space. Bulkheads may not be shown on this plan and may be located in areas of the Unit as required for venting and mechanical systems. All areas and stated dimensions are approximate. Actual usable floor space, living area and square footage may vary from stated floor area. All illustrations are artist's concept only. Furniture is depicted for illustration purposes only & are not included. The unit shown may be the reverse of the unit purchased. The exact location of any balcony (if applicable) in relation to the unit layout may differ from that shown. E & O.E.



**CHESTNUT HILL
DEVELOPMENTS**

BUILDING COMMUNITIES SINCE 1981

SUITE 1T+D

ONE BEDROOM + DEN

INTERIOR 683 SQ. FT. | EXTERIOR 62 SQ. FT. | TOTAL 745 SQ. FT.

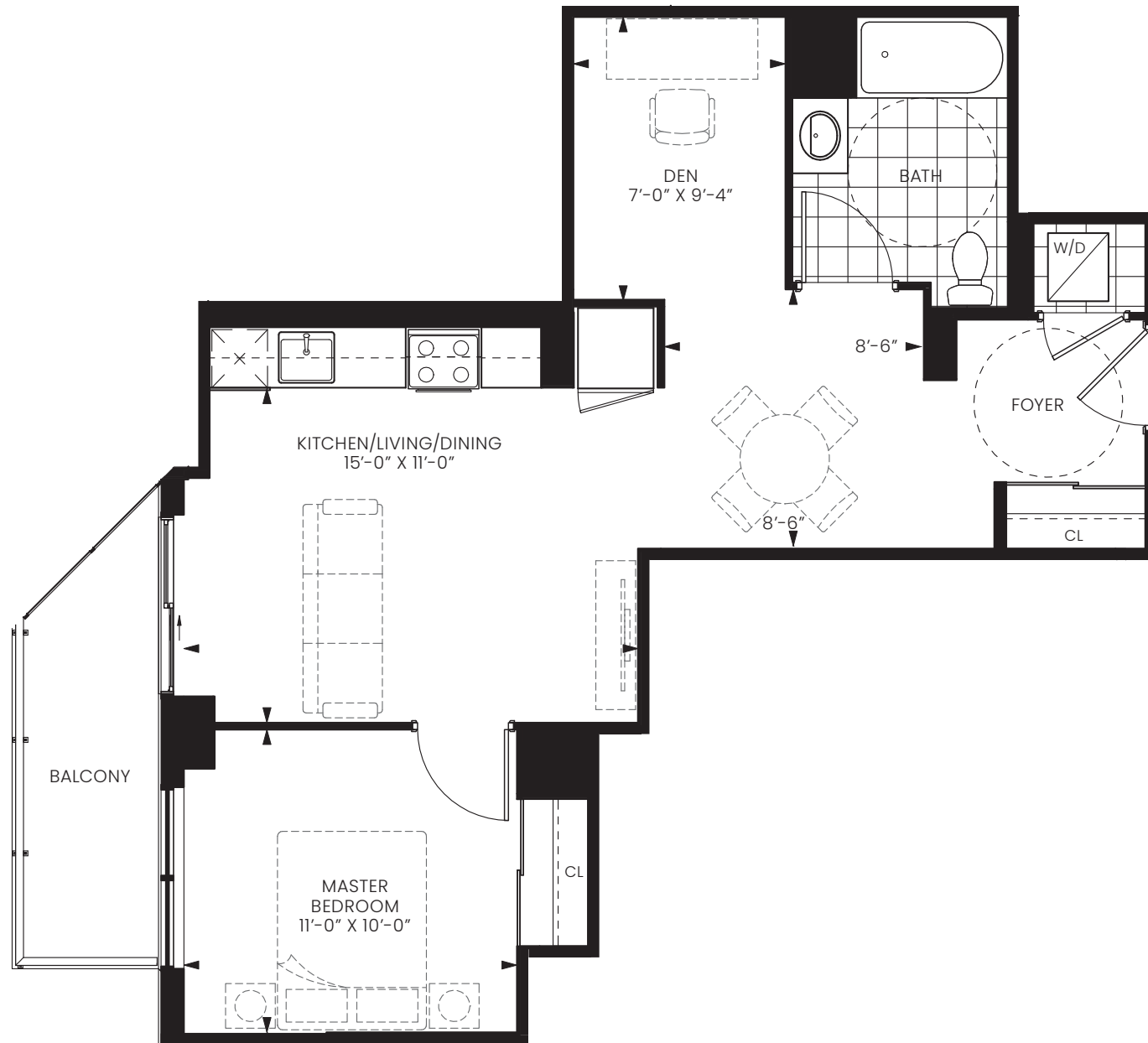

FLOOR 4

Note: All prices, figures, sizes, specifications and information, including without limitation the size, location, design and layout of windows, doors, walls, fixtures, closets, structures, appliances (if any), and the balcony are subject to change without notice to the Purchaser in order to comply with site conditions, municipal or governmental, structural, or architectural requirements, or for any reason at the discretion of the Vendor. Units on lower floors may have less floor space due to thicker structural members, mechanical rooms, etc. while units on higher floors may have more floor space. Bulkheads may not be shown on this plan and may be located in areas of the Unit as required for venting and mechanical systems. All areas and stated dimensions are approximate. Actual usable floor space, living area and square footage may vary from stated floor area. All illustrations are artist's concept only. Furniture is depicted for illustration purposes only & are not included. The unit shown may be the reverse of the unit purchased. The exact location of any balcony (if applicable) in relation to the unit layout may differ from that shown. E & O.E.



**CHESTNUT HILL
DEVELOPMENTS**

BUILDING COMMUNITIES SINCE 1981

SUITE 1W+D

ONE BEDROOM + DEN

INTERIOR 646 SQ. FT. | EXTERIOR 53 SQ. FT. | TOTAL 699 SQ. FT.

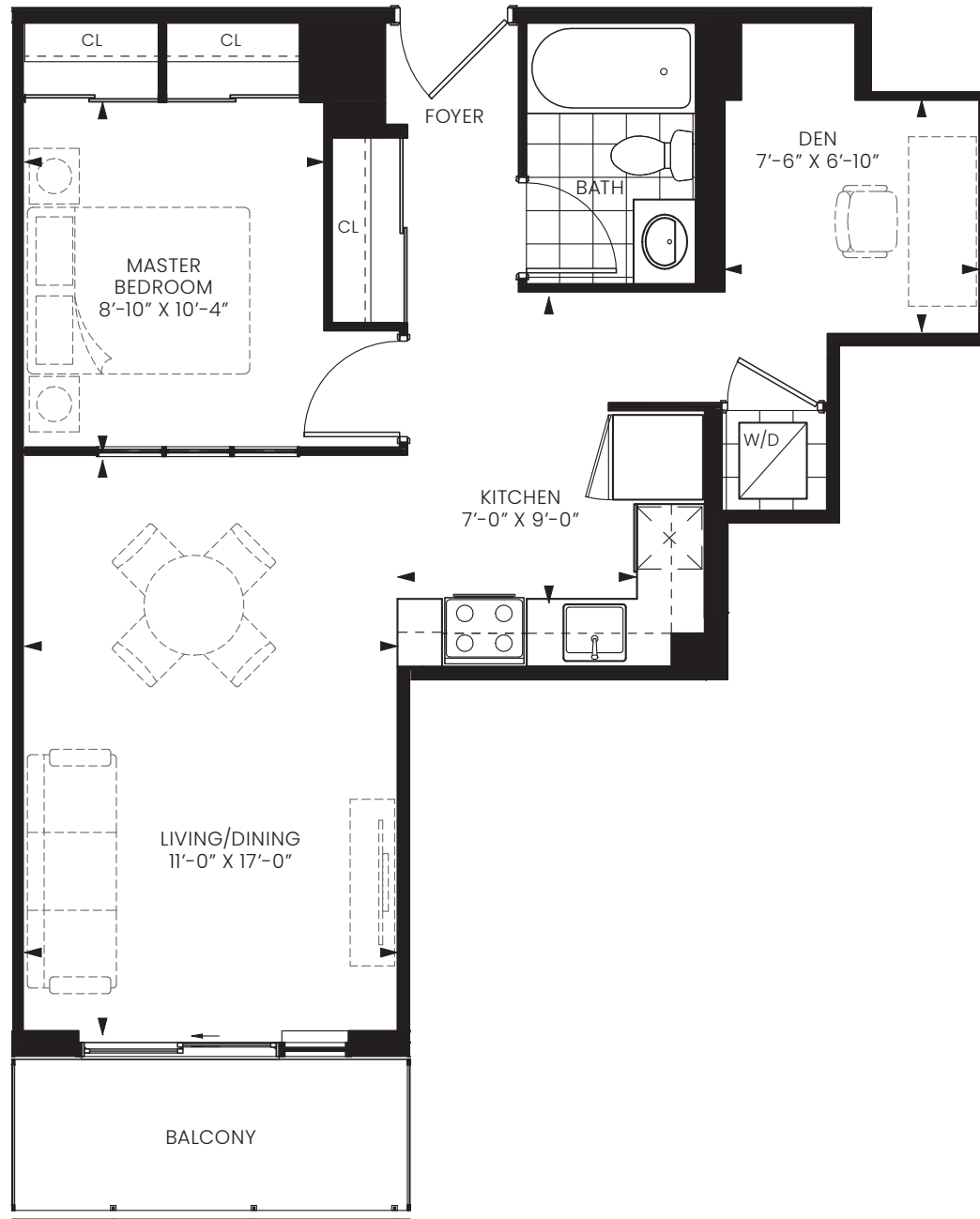

FLOOR 6

Note: All prices, figures, sizes, specifications and information, including without limitation the size, location, design and layout of windows, doors, walls, fixtures, closets, structures, appliances (if any), and the balcony are subject to change without notice to the Purchaser in order to comply with site conditions, municipal or governmental, structural, or architectural requirements, or for any reason at the discretion of the Vendor. Units on lower floors may have less floor space due to thicker structural members, mechanical rooms, etc. while units on higher floors may have more floor space. Bulkheads may not be shown on this plan and may be located in areas of the Unit as required for venting and mechanical systems. All areas and stated dimensions are approximate. Actual usable floor space, living area and square footage may vary from stated floor area. All illustrations are artist's concept only. Furniture is depicted for illustration purposes only & are not included. The unit shown may be the reverse of the unit purchased. The exact location of any balcony (if applicable) in relation to the unit layout may differ from that shown. E & O.E.



**CHESTNUT HILL
DEVELOPMENTS**

BUILDING COMMUNITIES SINCE 1981

SUITE 1X+D

ONE BEDROOM + DEN

INTERIOR 760 SQ. FT. | EXTERIOR 125 SQ. FT. | TOTAL 885 SQ. FT.

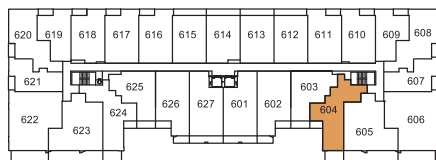
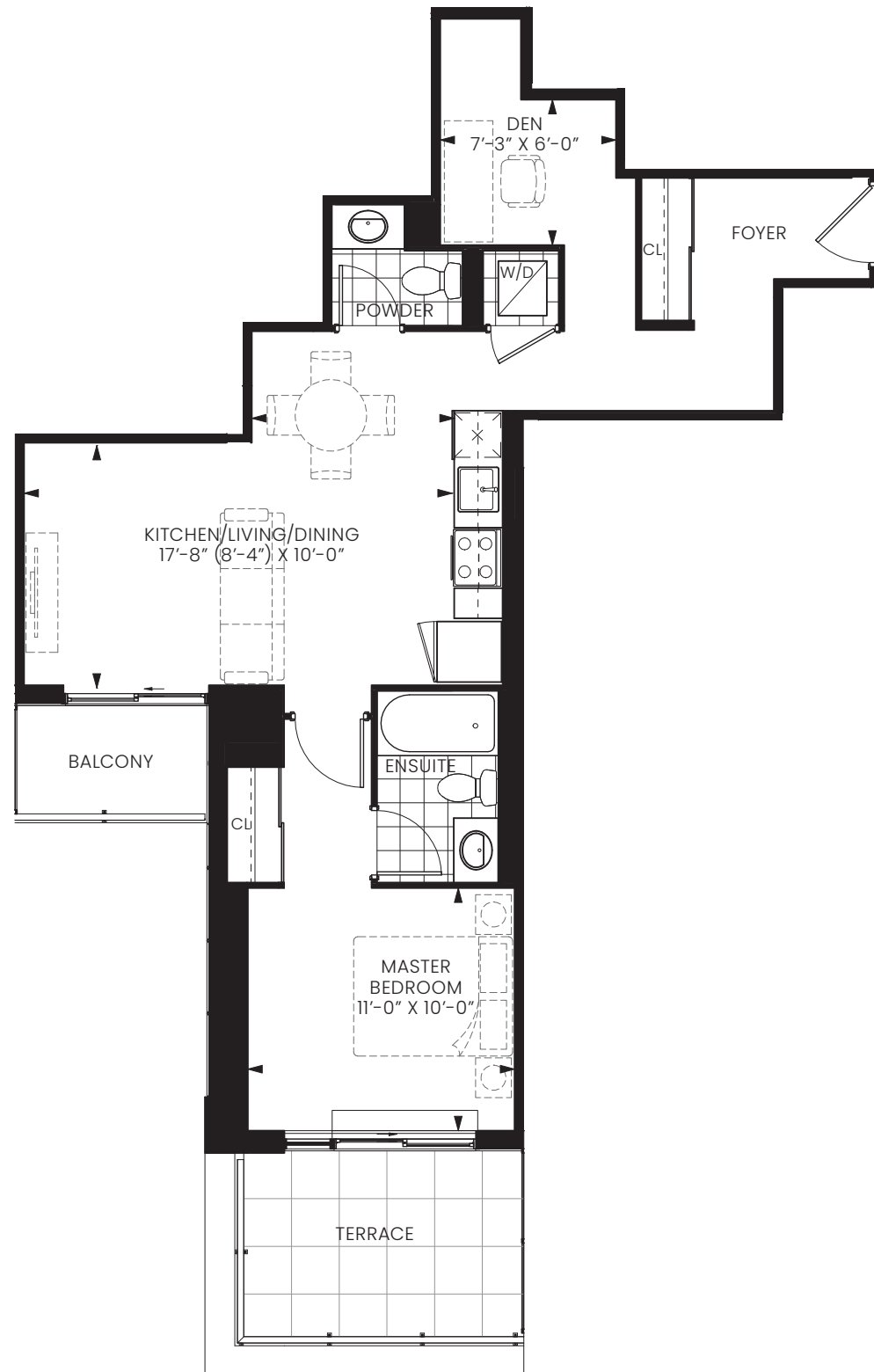

FLOOR 6

Note: All prices, figures, sizes, specifications and information, including without limitation the size, location, design and layout of windows, doors, walls, fixtures, closets, structures, appliances (if any), and the balcony are subject to change without notice to the Purchaser in order to comply with site conditions, municipal or governmental, structural, or architectural requirements, or for any reason at the discretion of the Vendor. Units on lower floors may have less floor space due to thicker structural members, mechanical rooms, etc. while units on higher floors may have more floor space. Bulkheads may not be shown on this plan and may be located in areas of the Unit as required for venting and mechanical systems. All areas and stated dimensions are approximate. Actual usable floor space, living area and square footage may vary from stated floor area. All illustrations are artist's concept only. Furniture is depicted for illustration purposes only & are not included. The unit shown may be the reverse of the unit purchased. The exact location of any balcony (if applicable) in relation to the unit layout may differ from that shown. E & O.E.



**CHESTNUT HILL
DEVELOPMENTS**

BUILDING COMMUNITIES SINCE 1981

SUITE 1Y+D

ONE BEDROOM + DEN

INTERIOR 721 SQ. FT. | EXTERIOR 125 SQ. FT. | TOTAL 846 SQ. FT.

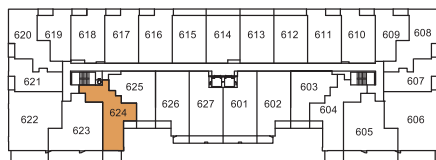
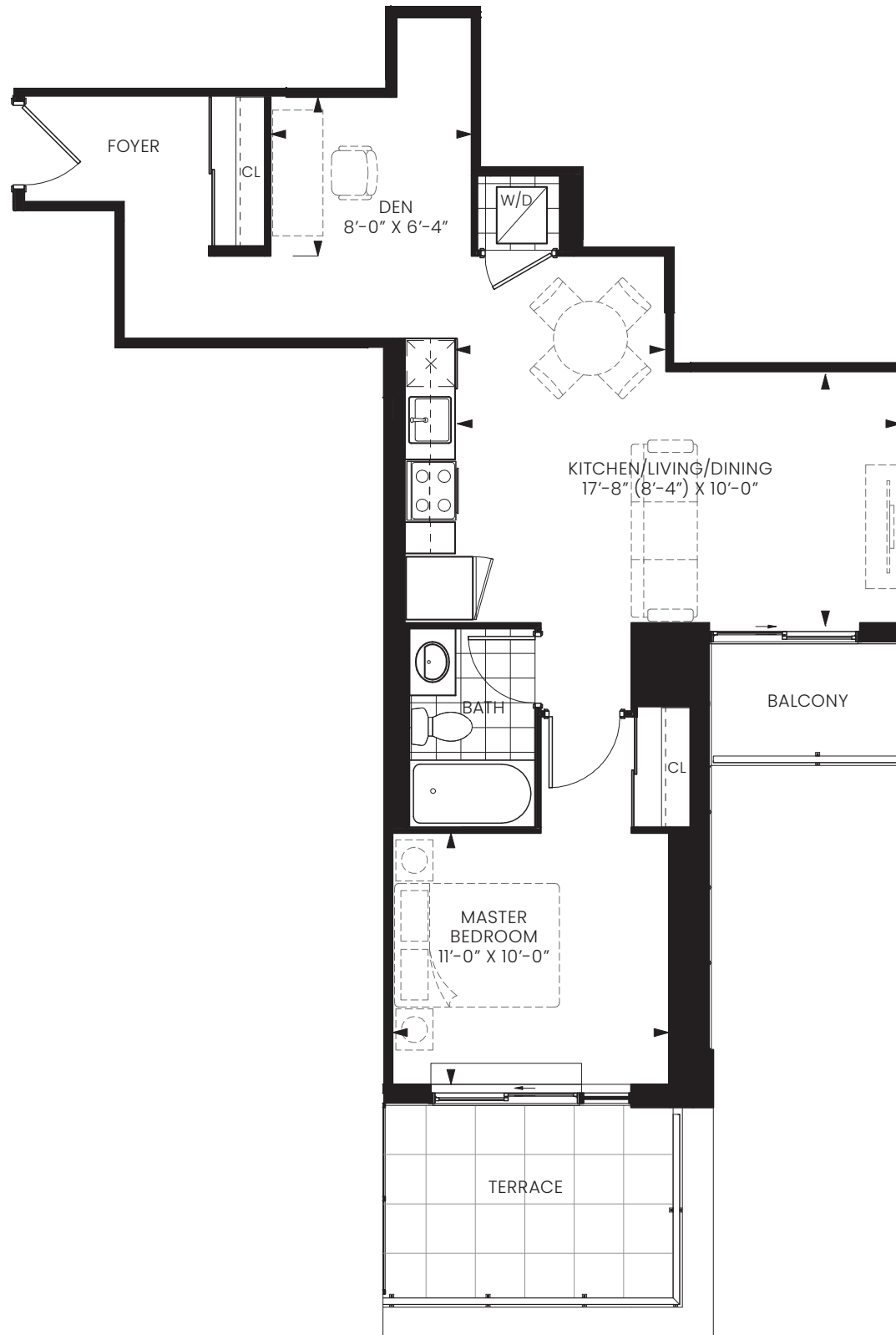

FLOOR 6

Note: All prices, figures, sizes, specifications and information, including without limitation the size, location, design and layout of windows, doors, walls, fixtures, closets, structures, appliances (if any), and the balcony are subject to change without notice to the Purchaser in order to comply with site conditions, municipal or governmental, structural, or architectural requirements, or for any reason at the discretion of the Vendor. Units on lower floors may have less floor space due to thicker structural members, mechanical rooms, etc. while units on higher floors may have more floor space. Bulkheads may not be shown on this plan and may be located in areas of the Unit as required for venting and mechanical systems. All areas and stated dimensions are approximate. Actual usable floor space, living area and square footage may vary from stated floor area. All illustrations are artist's concept only. Furniture is depicted for illustration purposes only & are not included. The unit shown may be the reverse of the unit purchased. The exact location of any balcony (if applicable) in relation to the unit layout may differ from that shown. E & O.E.



**CHESTNUT HILL
DEVELOPMENTS**

BUILDING COMMUNITIES SINCE 1981

SUITE 1GG + D

ONE BEDROOM + DEN

INTERIOR 645 SQ. FT. | EXTERIOR 101 SQ. FT. | TOTAL 746 SQ. FT.

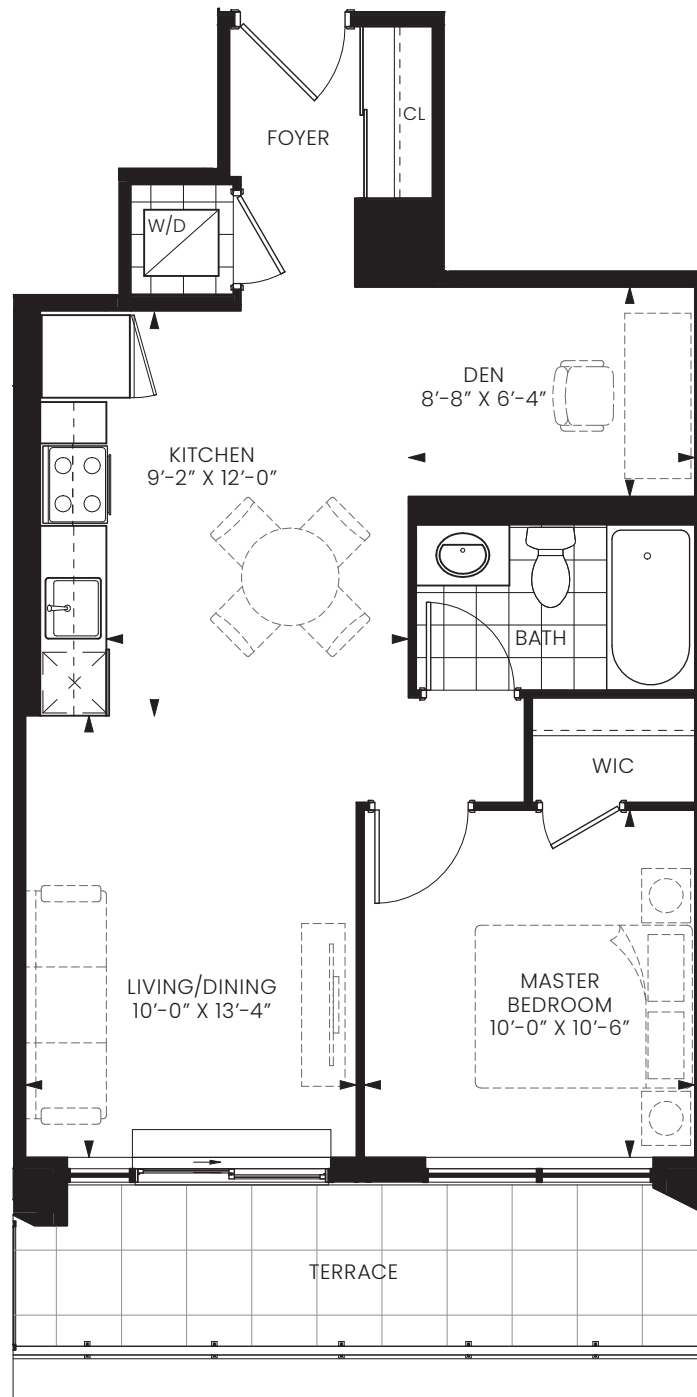

FLOOR 4

Note: All prices, figures, sizes, specifications and information, including without limitation the size, location, design and layout of windows, doors, walls, fixtures, closets, structures, appliances (if any), and the balcony are subject to change without notice to the Purchaser in order to comply with site conditions, municipal or governmental, structural, or architectural requirements, or for any reason at the discretion of the Vendor. Units on lower floors may have less floor space due to thicker structural members, mechanical rooms, etc. while units on higher floors may have more floor space. Bulkheads may not be shown on this plan and may be located in areas of the Unit as required for venting and mechanical systems. All areas and stated dimensions are approximate. Actual usable floor space, living area and square footage may vary from stated floor area. All illustrations are artist's concept only. Furniture is depicted for illustration purposes only & are not included. The unit shown may be the reverse of the unit purchased. The exact location of any balcony (if applicable) in relation to the unit layout may differ from that shown. E & O.E.



**CHESTNUT HILL
DEVELOPMENTS**

BUILDING COMMUNITIES SINCE 1981

SUITE 1JJ+D

ONE BEDROOM + DEN

INTERIOR 607 SQ. FT. | EXTERIOR 90 SQ. FT. | TOTAL 697 SQ. FT.

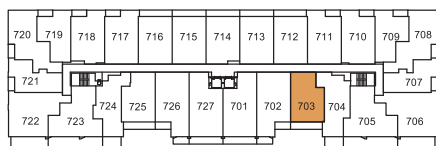
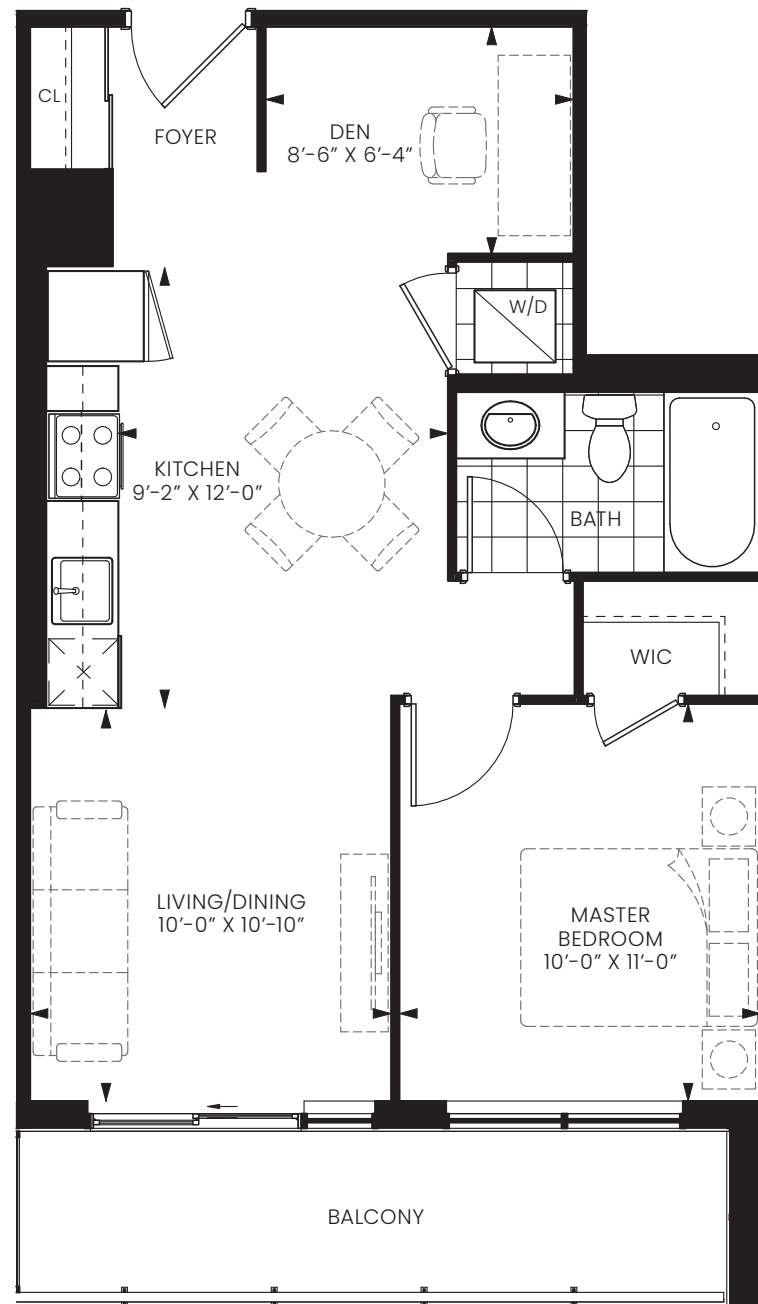

FLOOR 7

Note: All prices, figures, sizes, specifications and information, including without limitation the size, location, design and layout of windows, doors, walls, fixtures, closets, structures, appliances (if any), and the balcony are subject to change without notice to the Purchaser in order to comply with site conditions, municipal or governmental, structural, or architectural requirements, or for any reason at the discretion of the Vendor. Units on lower floors may have less floor space due to thicker structural members, mechanical rooms, etc. while units on higher floors may have more floor space. Bulkheads may not be shown on this plan and may be located in areas of the Unit as required for venting and mechanical systems. All areas and stated dimensions are approximate. Actual usable floor space, living area and square footage may vary from stated floor area. All illustrations are artist's concept only. Furniture is depicted for illustration purposes only & are not included. The unit shown may be the reverse of the unit purchased. The exact location of any balcony (if applicable) in relation to the unit layout may differ from that shown. E & O.E.



**CHESTNUT HILL
DEVELOPMENTS**

BUILDING COMMUNITIES SINCE 1981

SUITE 1LL+D

ONE BEDROOM + DEN

INTERIOR 671 SQ. FT. | EXTERIOR 37 SQ. FT. | TOTAL 708 SQ. FT.

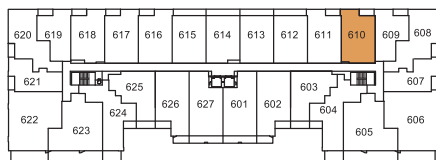
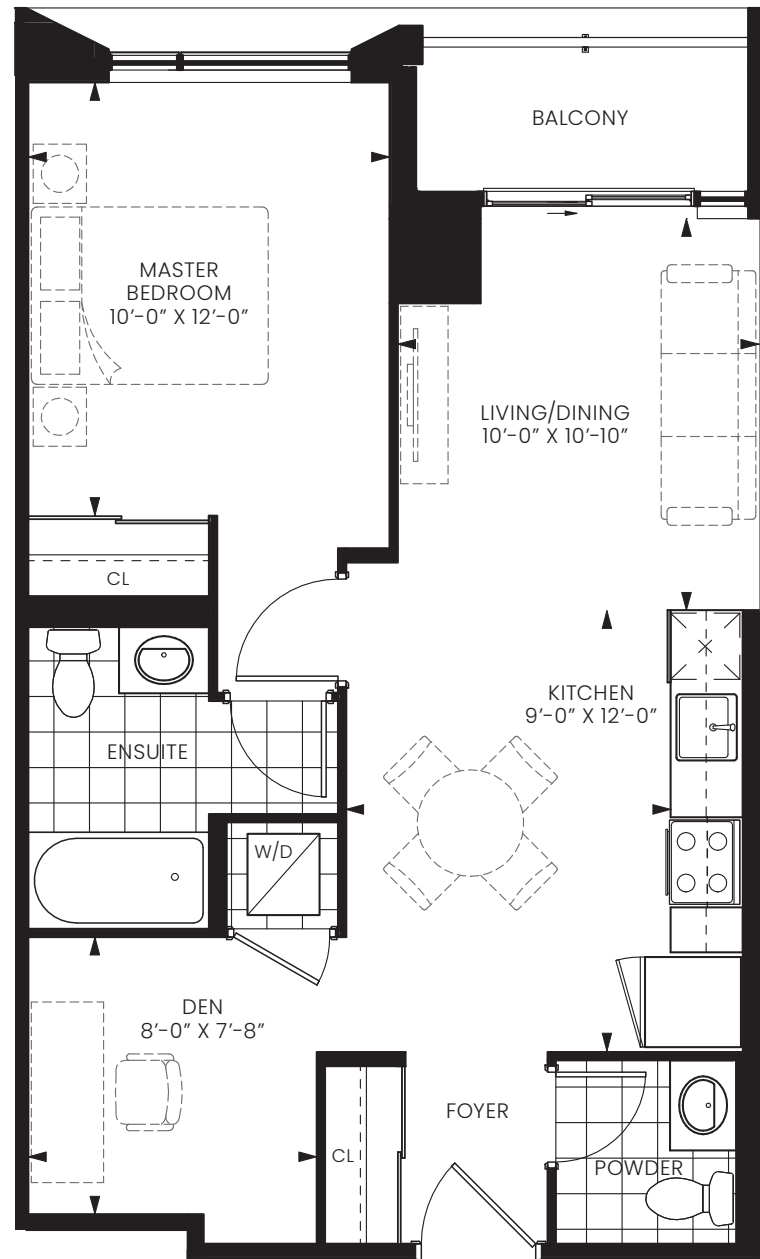

FLOOR 6

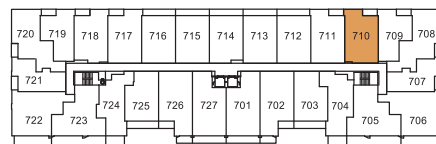

FLOOR 7

Note: All prices, figures, sizes, specifications and information, including without limitation the size, location, design and layout of windows, doors, walls, fixtures, closets, structures, appliances (if any), and the balcony are subject to change without notice to the Purchaser in order to comply with site conditions, municipal or governmental, structural, or architectural requirements, or for any reason at the discretion of the Vendor. Units on lower floors may have less floor space due to thicker structural members, mechanical rooms, etc. while units on higher floors may have more floor space. Bulkheads may not be shown on this plan and may be located in areas of the Unit as required for venting and mechanical systems. All areas and stated dimensions are approximate. Actual usable floor space, living area and square footage may vary from stated floor area. All illustrations are artist's concept only. Furniture is depicted for illustration purposes only & are not included. The unit shown may be the reverse of the unit purchased. The exact location of any balcony (if applicable) in relation to the unit layout may differ from that shown. E & O.E.



**CHESTNUT HILL
DEVELOPMENTS**

BUILDING COMMUNITIES SINCE 1981

SUITE 1NN + D

ONE BEDROOM + DEN

INTERIOR 607 SQ. FT. | EXTERIOR 90 SQ. FT. | TOTAL 697 SQ. FT.

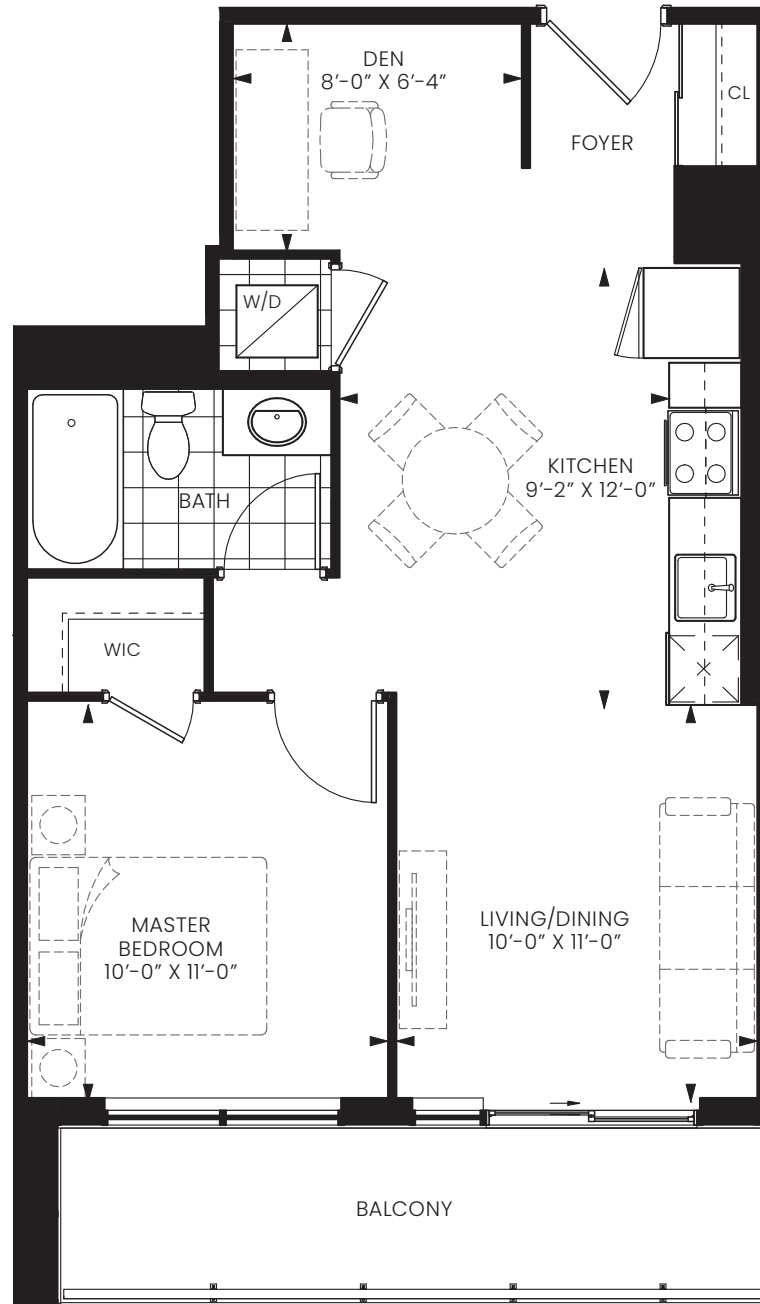

FLOOR 7

Note: All prices, figures, sizes, specifications and information, including without limitation the size, location, design and layout of windows, doors, walls, fixtures, closets, structures, appliances (if any), and the balcony are subject to change without notice to the Purchaser in order to comply with site conditions, municipal or governmental, structural, or architectural requirements, or for any reason at the discretion of the Vendor. Units on lower floors may have less floor space due to thicker structural members, mechanical rooms, etc. while units on higher floors may have more floor space. Bulkheads may not be shown on this plan and may be located in areas of the Unit as required for venting and mechanical systems. All areas and stated dimensions are approximate. Actual usable floor space, living area and square footage may vary from stated floor area. All illustrations are artist's concept only. Furniture is depicted for illustration purposes only & are not included. The unit shown may be the reverse of the unit purchased. The exact location of any balcony (if applicable) in relation to the unit layout may differ from that shown. E & O.E.



**CHESTNUT HILL
DEVELOPMENTS**

BUILDING COMMUNITIES SINCE 1981

SUITE 2A

TWO BEDROOM

INTERIOR 761 SQ. FT. | EXTERIOR 94 SQ. FT. | TOTAL 855 SQ. FT.

EXTERIOR AT 2ND 213 & 208 SQ. FT.

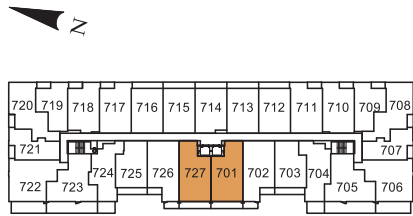

FLOOR 7

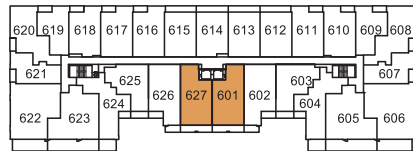

FLOOR 6

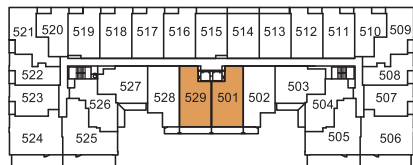

FLOOR 5

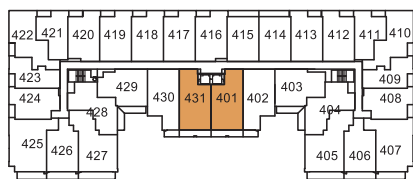

FLOOR 4

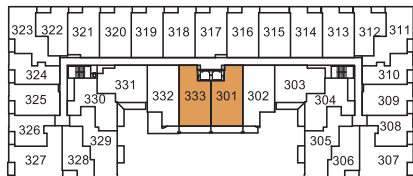

FLOOR 3

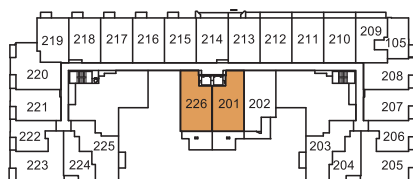

FLOOR 2

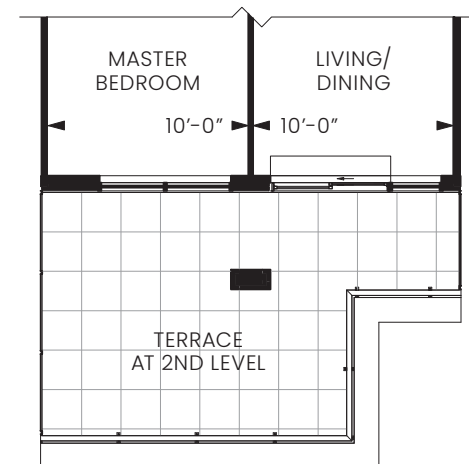
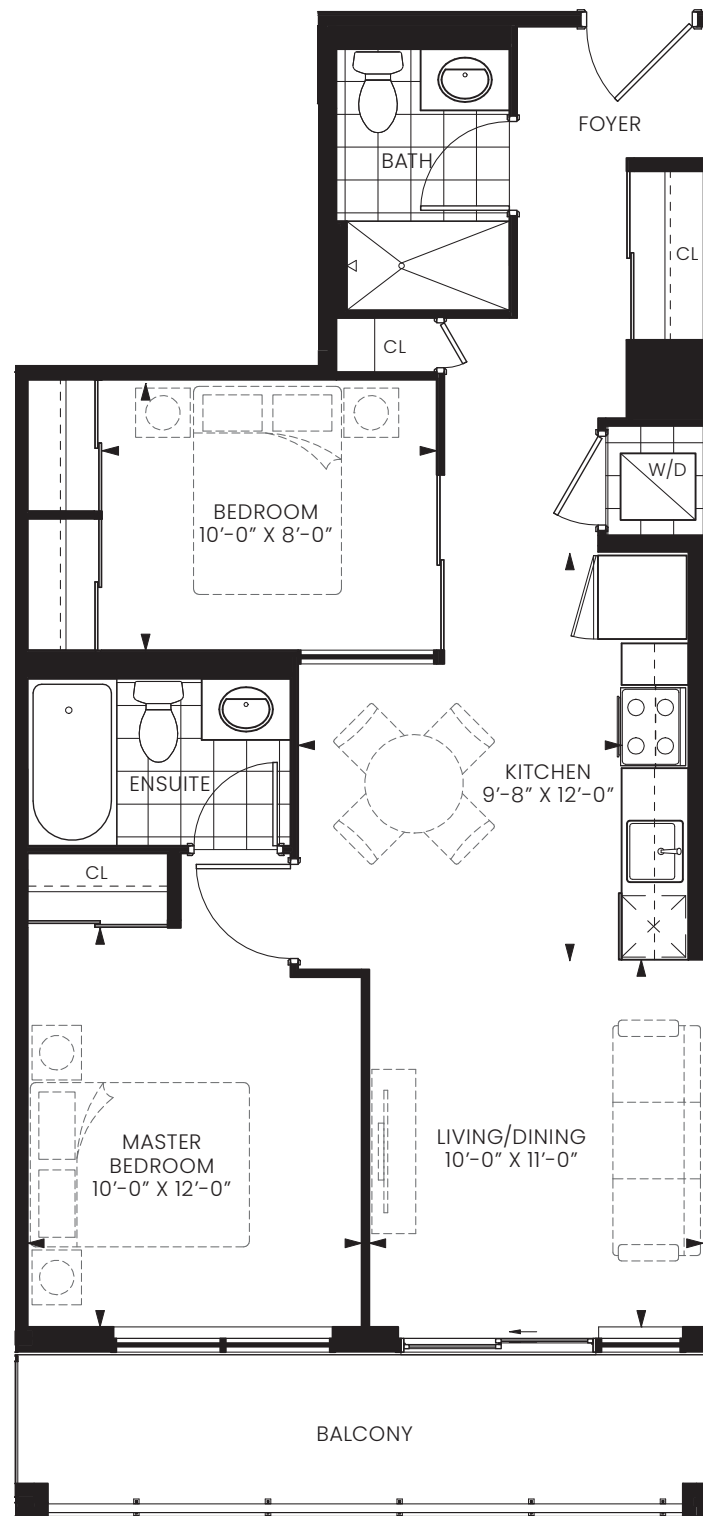

Note: All prices, figures, sizes, specifications and information, including without limitation the size, location, design and layout of windows, doors, walls, fixtures, closets, structures, appliances (if any), and the balcony are subject to change without notice to the Purchaser in order to comply with site conditions, municipal or governmental, structural, or architectural requirements, or for any reason at the discretion of the Vendor. Units on lower floors may have less floor space due to thicker structural members, mechanical rooms, etc. while units on higher floors may have more floor space. Bulkheads may not be shown on this plan and may be located in areas of the Unit as required for venting and mechanical systems. All areas and stated dimensions are approximate. Actual usable floor space, living area and square footage may vary from stated floor area. All illustrations are artist's concept only. Furniture is depicted for illustration purposes only & are not included. The unit shown may be the reverse of the unit purchased. The exact location of any balcony (if applicable) in relation to the unit layout may differ from that shown. E & O.E.



**CHESTNUT HILL
DEVELOPMENTS**

BUILDING COMMUNITIES SINCE 1981

SUITE 2B

TWO BEDROOM

INTERIOR 857 SQ. FT. | EXTERIOR 38 SQ. FT. | TOTAL 895 SQ. FT.

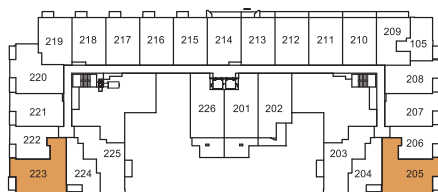
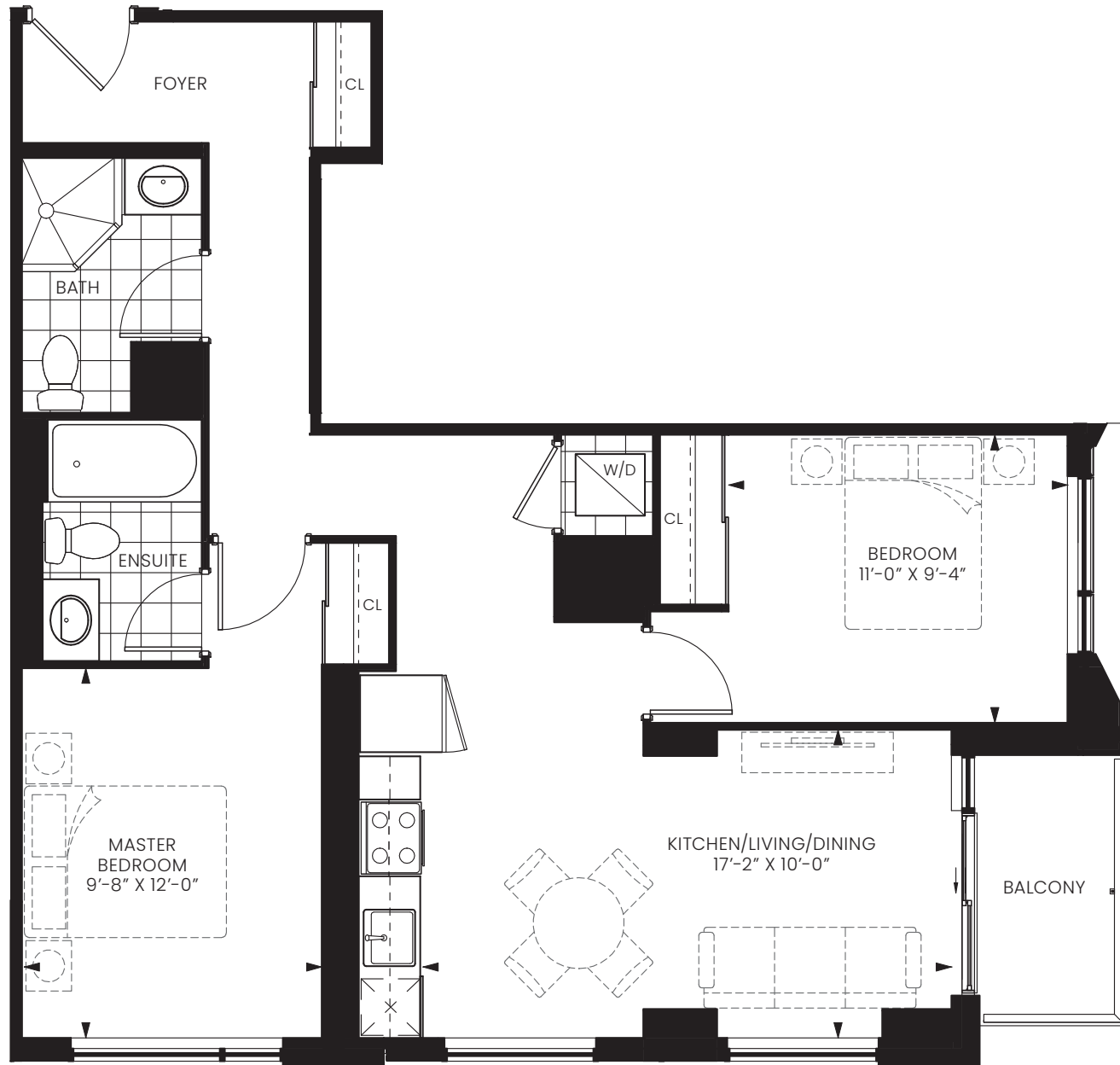

FLOOR 2

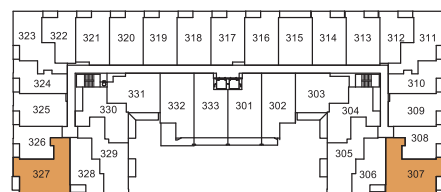

FLOOR 3

Note: All prices, figures, sizes, specifications and information, including without limitation the size, location, design and layout of windows, doors, walls, fixtures, closets, structures, appliances (if any), and the balcony are subject to change without notice to the Purchaser in order to comply with site conditions, municipal or governmental, structural, or architectural requirements, or for any reason at the discretion of the Vendor. Units on lower floors may have less floor space due to thicker structural members, mechanical rooms, etc. while units on higher floors may have more floor space. Bulkheads may not be shown on this plan and may be located in areas of the Unit as required for venting and mechanical systems. All areas and stated dimensions are approximate. Actual usable floor space, living area and square footage may vary from stated floor area. All illustrations are artist's concept only. Furniture is depicted for illustration purposes only & are not included. The unit shown may be the reverse of the unit purchased. The exact location of any balcony (if applicable) in relation to the unit layout may differ from that shown. E & O.E.



**CHESTNUT HILL
DEVELOPMENTS**

BUILDING COMMUNITIES SINCE 1981

SUITE 2C

TWO BEDROOM

INTERIOR | 781 SQ. FT. | EXTERIOR 70 SQ. FT. | TOTAL 851 SQ. FT.

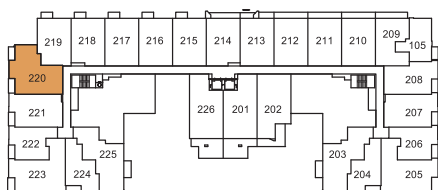
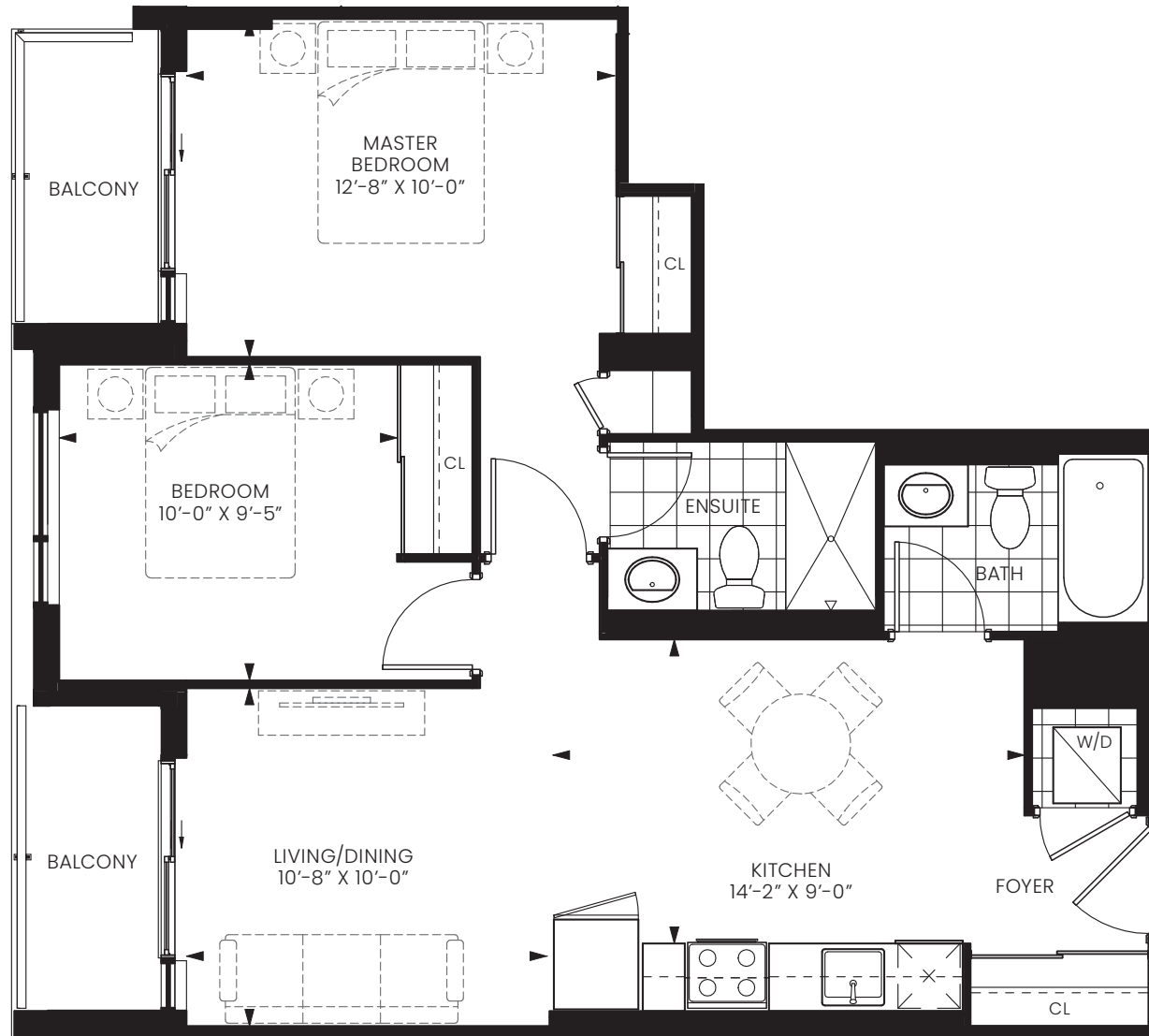

FLOOR 2

Note: All prices, figures, sizes, specifications and information, including without limitation the size, location, design and layout of windows, doors, walls, fixtures, closets, structures, appliances (if any), and the balcony are subject to change without notice to the Purchaser in order to comply with site conditions, municipal or governmental, structural, or architectural requirements, or for any reason at the discretion of the Vendor. Units on lower floors may have less floor space due to thicker structural members, mechanical rooms, etc. while units on higher floors may have more floor space. Bulkheads may not be shown on this plan and may be located in areas of the Unit as required for venting and mechanical systems. All areas and stated dimensions are approximate. Actual usable floor space, living area and square footage may vary from stated floor area. All illustrations are artist's concept only. Furniture is depicted for illustration purposes only & are not included. The unit shown may be the reverse of the unit purchased. The exact location of any balcony (if applicable) in relation to the unit layout may differ from that shown. E & O.E.



**CHESTNUT HILL
DEVELOPMENTS**

BUILDING COMMUNITIES SINCE 1981

SUITE 2E

TWO BEDROOM

INTERIOR 828 SQ. FT. | EXTERIOR 177 SQ. FT. | TOTAL 1,005 SQ. FT.

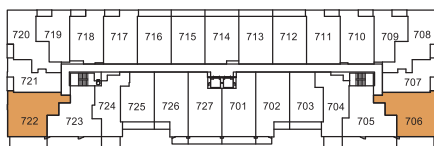
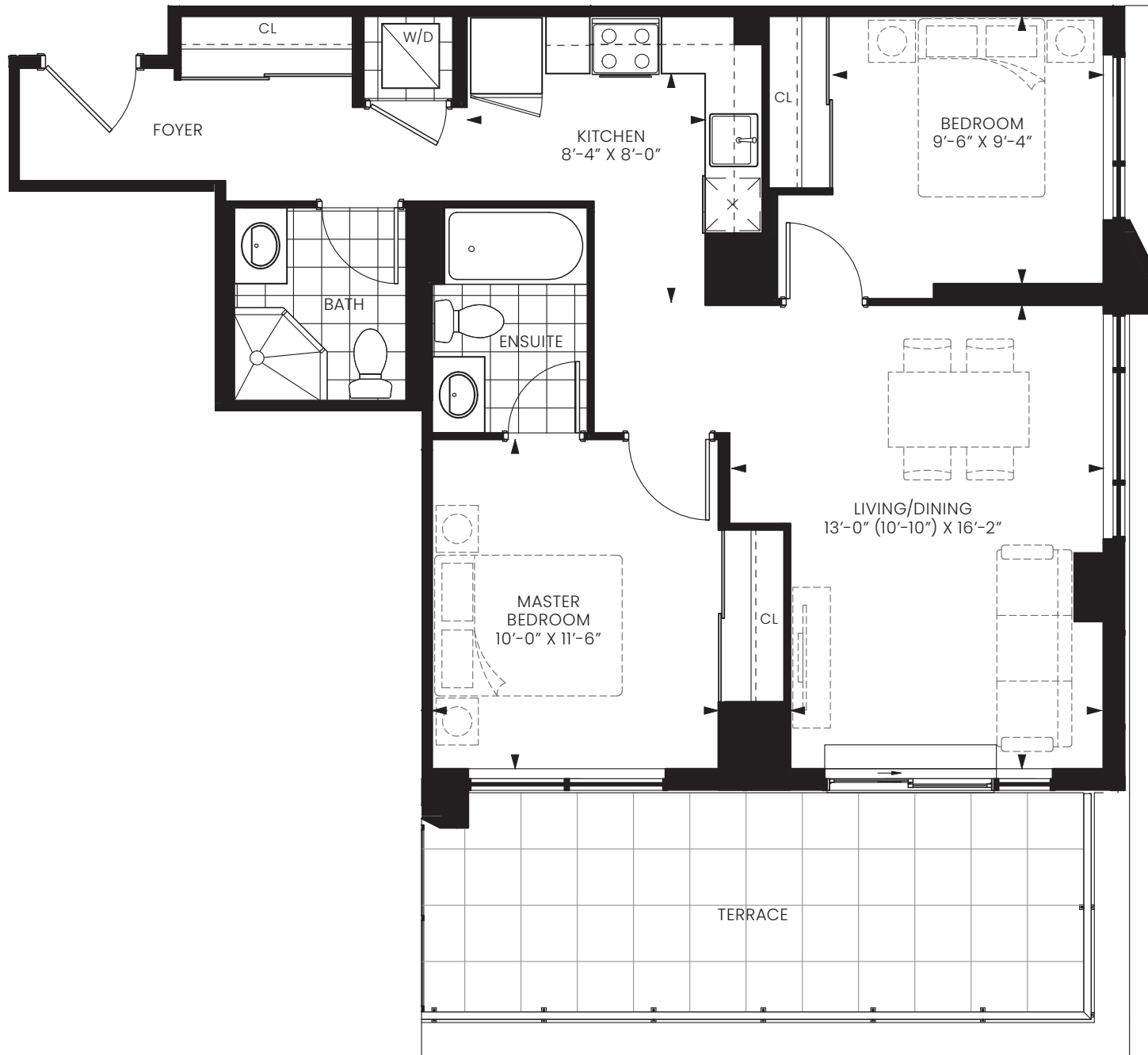

FLOOR 7

Note: All prices, figures, sizes, specifications and information, including without limitation the size, location, design and layout of windows, doors, walls, fixtures, closets, structures, appliances (if any), and the balcony are subject to change without notice to the Purchaser in order to comply with site conditions, municipal or governmental, structural, or architectural requirements, or for any reason at the discretion of the Vendor. Units on lower floors may have less floor space due to thicker structural members, mechanical rooms, etc. while units on higher floors may have more floor space. Bulkheads may not be shown on this plan and may be located in areas of the Unit as required for venting and mechanical systems. All areas and stated dimensions are approximate. Actual usable floor space, living area and square footage may vary from stated floor area. All illustrations are artist's concept only. Furniture is depicted for illustration purposes only & are not included. The unit shown may be the reverse of the unit purchased. The exact location of any balcony (if applicable) in relation to the unit layout may differ from that shown. E & O.E.



**CHESTNUT HILL
DEVELOPMENTS**

BUILDING COMMUNITIES SINCE 1981

SUITE 2G

TWO BEDROOM (LOFT)

INTERIOR 843 SQ. FT. | EXTERIOR 333 SQ. FT. | TOTAL 1,176 SQ. FT.

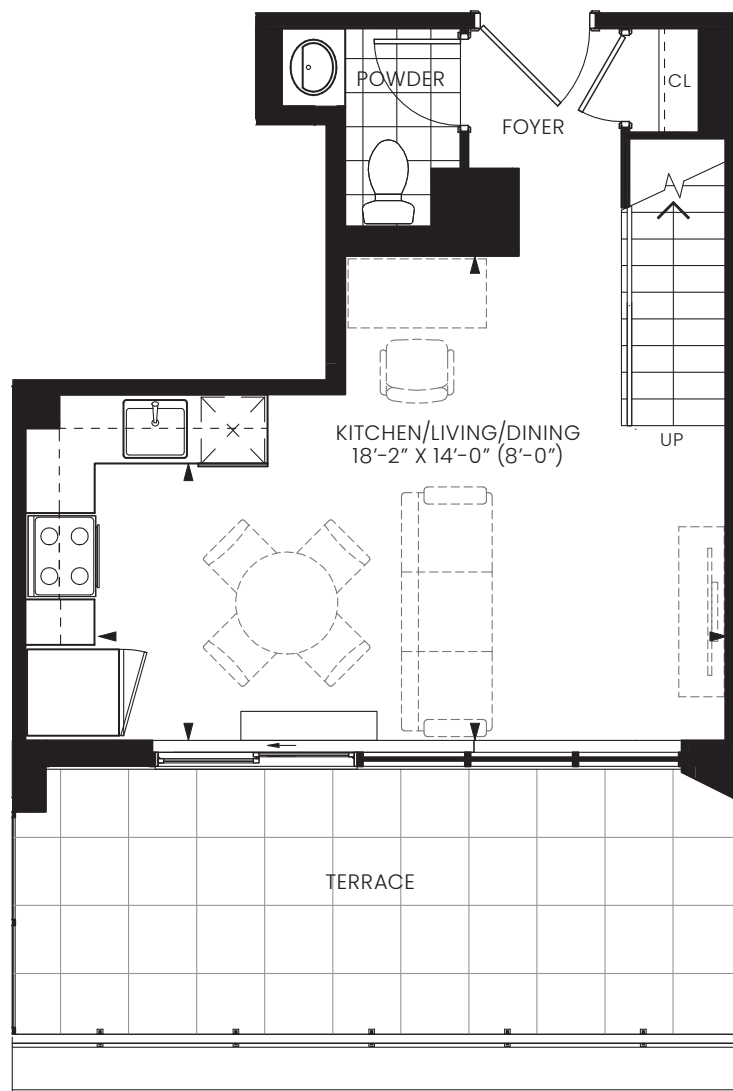

9TH FLOOR

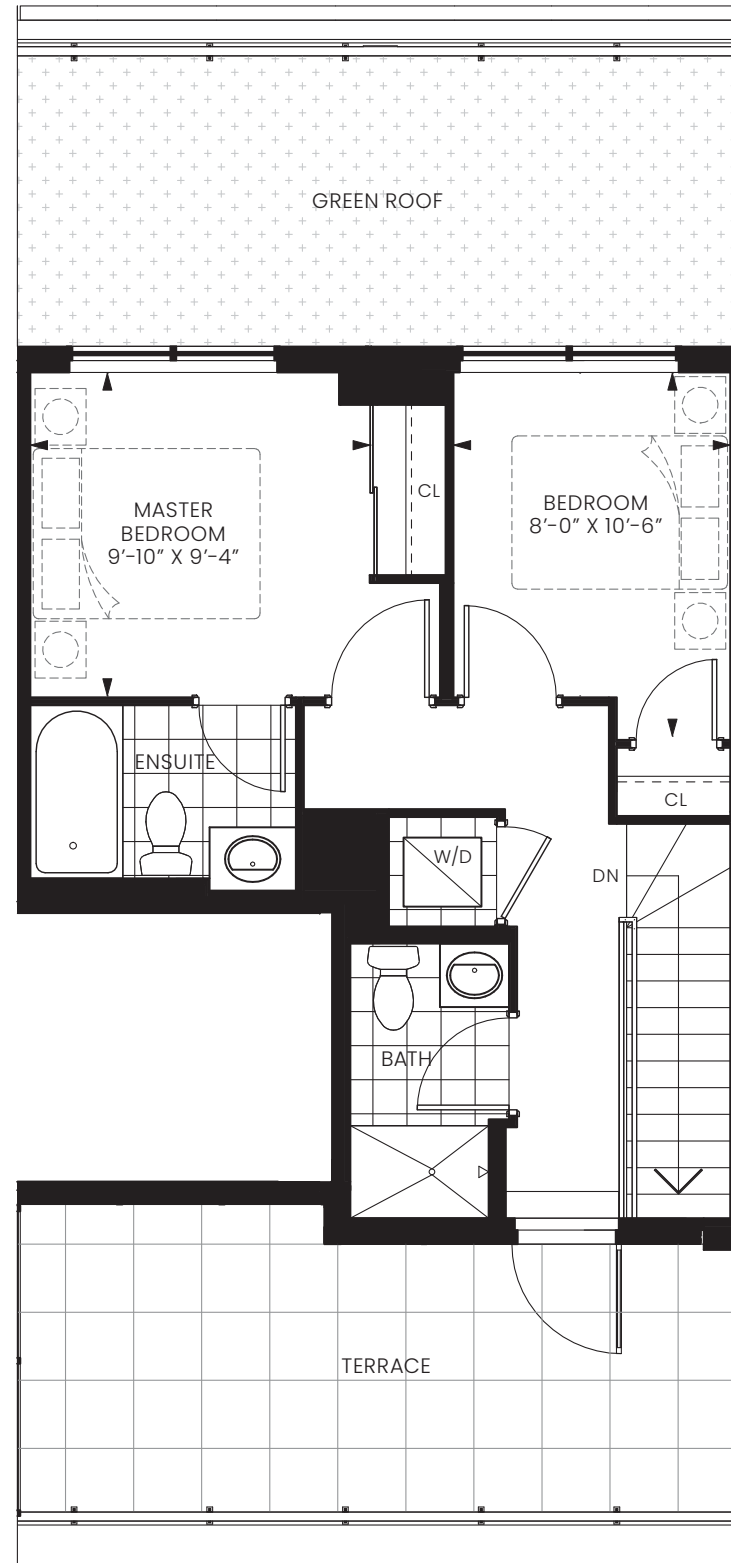

10TH FLOOR

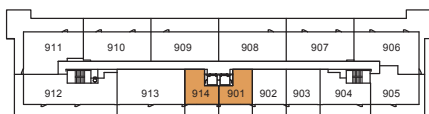

FLOOR 9

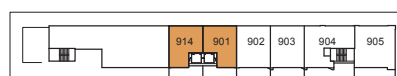

FLOOR 10

Note: All prices, figures, sizes, specifications and information, including without limitation the size, location, design and layout of windows, doors, walls, fixtures, closets, structures, appliances (if any), and the balcony are subject to change without notice to the Purchaser in order to comply with site conditions, municipal or governmental, structural, or architectural requirements, or for any reason at the discretion of the Vendor. Units on lower floors may have less floor space due to thicker structural members, mechanical rooms, etc. while units on higher floors may have more floor space. Bulkheads may not be shown on this plan and may be located in areas of the Unit as required for venting and mechanical systems. All areas and stated dimensions are approximate. Actual usable floor space, living area and square footage may vary from stated floor area. All illustrations are artist's concept only. Furniture is depicted for illustration purposes only & are not included. The unit shown may be the reverse of the unit purchased. The exact location of any balcony (if applicable) in relation to the unit layout may differ from that shown. E & O.E.



CHESTNUT HILL DEVELOPMENTS

BUILDING COMMUNITIES SINCE 1981

SUITE 2H

TWO BEDROOM

INTERIOR 773 SQ. FT. | EXTERIOR 347 SQ. FT. | TOTAL 1,120 SQ. FT.

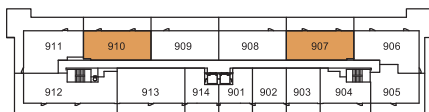
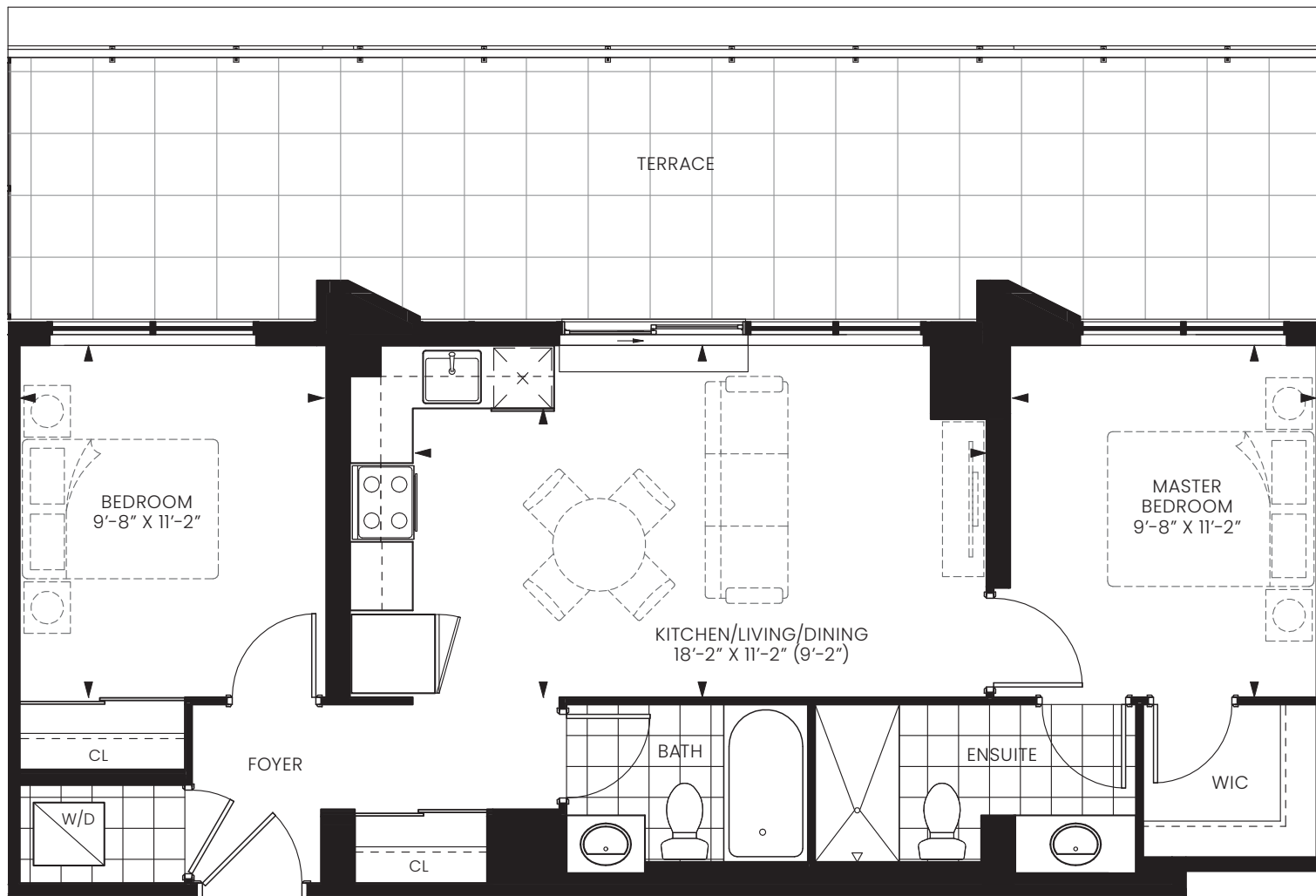

FLOOR 9

Note: All prices, figures, sizes, specifications and information, including without limitation the size, location, design and layout of windows, doors, walls, fixtures, closets, structures, appliances (if any), and the balcony are subject to change without notice to the Purchaser in order to comply with site conditions, municipal or governmental, structural, or architectural requirements, or for any reason at the discretion of the Vendor. Units on lower floors may have less floor space due to thicker structural members, mechanical rooms, etc. while units on higher floors may have more floor space. Bulkheads may not be shown on this plan and may be located in areas of the Unit as required for venting and mechanical systems. All areas and stated dimensions are approximate. Actual usable floor space, living area and square footage may vary from stated floor area. All illustrations are artist's concept only. Furniture is depicted for illustration purposes only & are not included. The unit shown may be the reverse of the unit purchased. The exact location of any balcony (if applicable) in relation to the unit layout may differ from that shown. E & O.E.



**CHESTNUT HILL
DEVELOPMENTS**

BUILDING COMMUNITIES SINCE 1981

SUITE 2J

TWO BEDROOM

INTERIOR 776 SQ. FT. | EXTERIOR 350 SQ. FT. | TOTAL 1,126 SQ. FT.

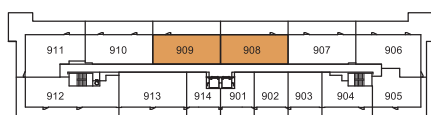
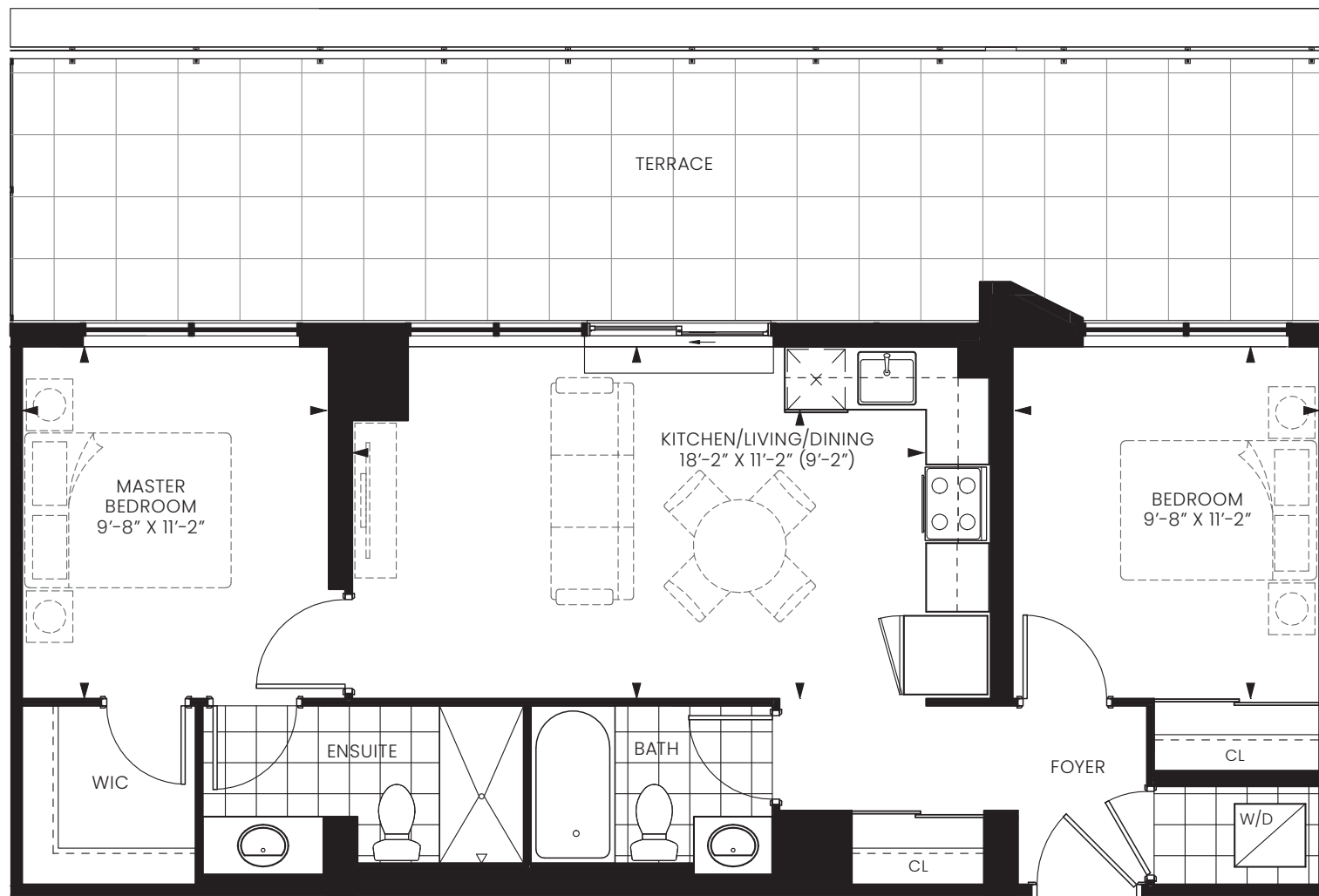

FLOOR 9

Note: All prices, figures, sizes, specifications and information, including without limitation the size, location, design and layout of windows, doors, walls, fixtures, closets, structures, appliances (if any), and the balcony are subject to change without notice to the Purchaser in order to comply with site conditions, municipal or governmental, structural, or architectural requirements, or for any reason at the discretion of the Vendor. Units on lower floors may have less floor space due to thicker structural members, mechanical rooms, etc. while units on higher floors may have more floor space. Bulkheads may not be shown on this plan and may be located in areas of the Unit as required for venting and mechanical systems. All areas and stated dimensions are approximate. Actual usable floor space, living area and square footage may vary from stated floor area. All illustrations are artist's concept only. Furniture is depicted for illustration purposes only & are not included. The unit shown may be the reverse of the unit purchased. The exact location of any balcony (if applicable) in relation to the unit layout may differ from that shown. E & O.E.



**CHESTNUT HILL
DEVELOPMENTS**

BUILDING COMMUNITIES SINCE 1981

SUITE 2K

TWO BEDROOM

INTERIOR 744 SQ. FT. | EXTERIOR 34 SQ. FT. | TOTAL 778 SQ. FT.

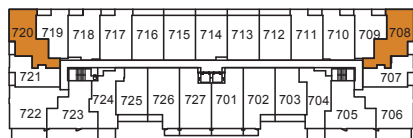
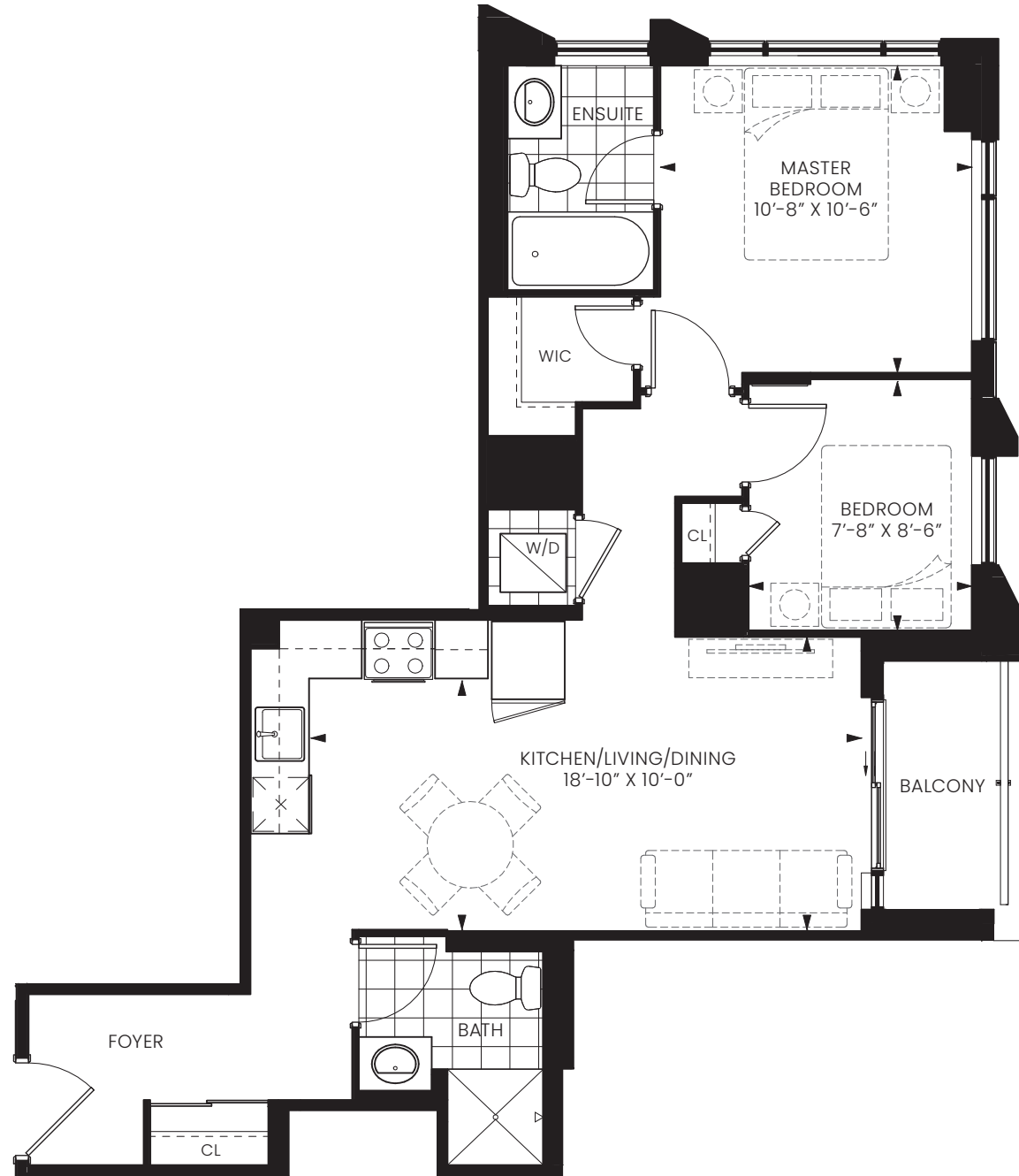

FLOOR 7

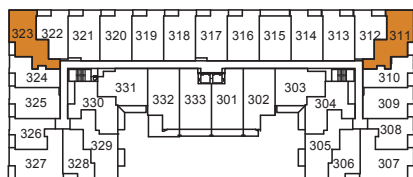

FLOOR 3

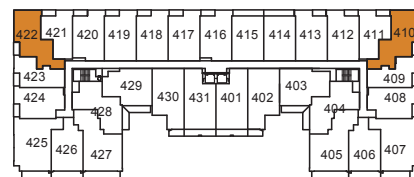

FLOOR 4

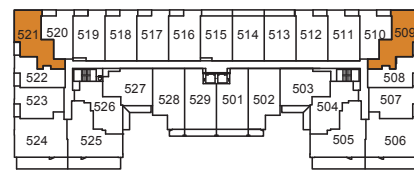

FLOOR 5

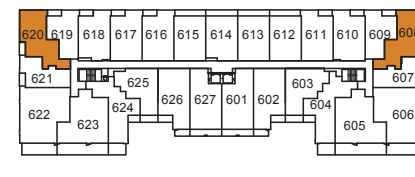

FLOOR 6



Note: All prices, figures, sizes, specifications and information, including without limitation the size, location, design and layout of windows, doors, walls, fixtures, closets, structures, appliances (if any), and the balcony are subject to change without notice to the Purchaser in order to comply with site conditions, municipal or governmental, structural, or architectural requirements, or for any reason at the discretion of the Vendor. Units on lower floors may have less floor space due to thicker structural members, mechanical rooms, etc. while units on higher floors may have more floor space. Bulkheads may not be shown on this plan and may be located in areas of the Unit as required for venting and mechanical systems. All areas and stated dimensions are approximate. Actual usable floor space, living area and square footage may vary from stated floor area. All illustrations are artist's concept only. Furniture is depicted for illustration purposes only & are not included. The unit shown may be the reverse of the unit purchased. The exact location of any balcony (if applicable) in relation to the unit layout may differ from that shown. E. & O.E.



**CHESTNUT HILL
DEVELOPMENTS**

BUILDING COMMUNITIES SINCE 1981

SUITE 2A+D

TWO BEDROOM + DEN

INTERIOR 892 SQ. FT. | EXTERIOR 119 SQ. FT. | TOTAL 1,011 SQ. FT.

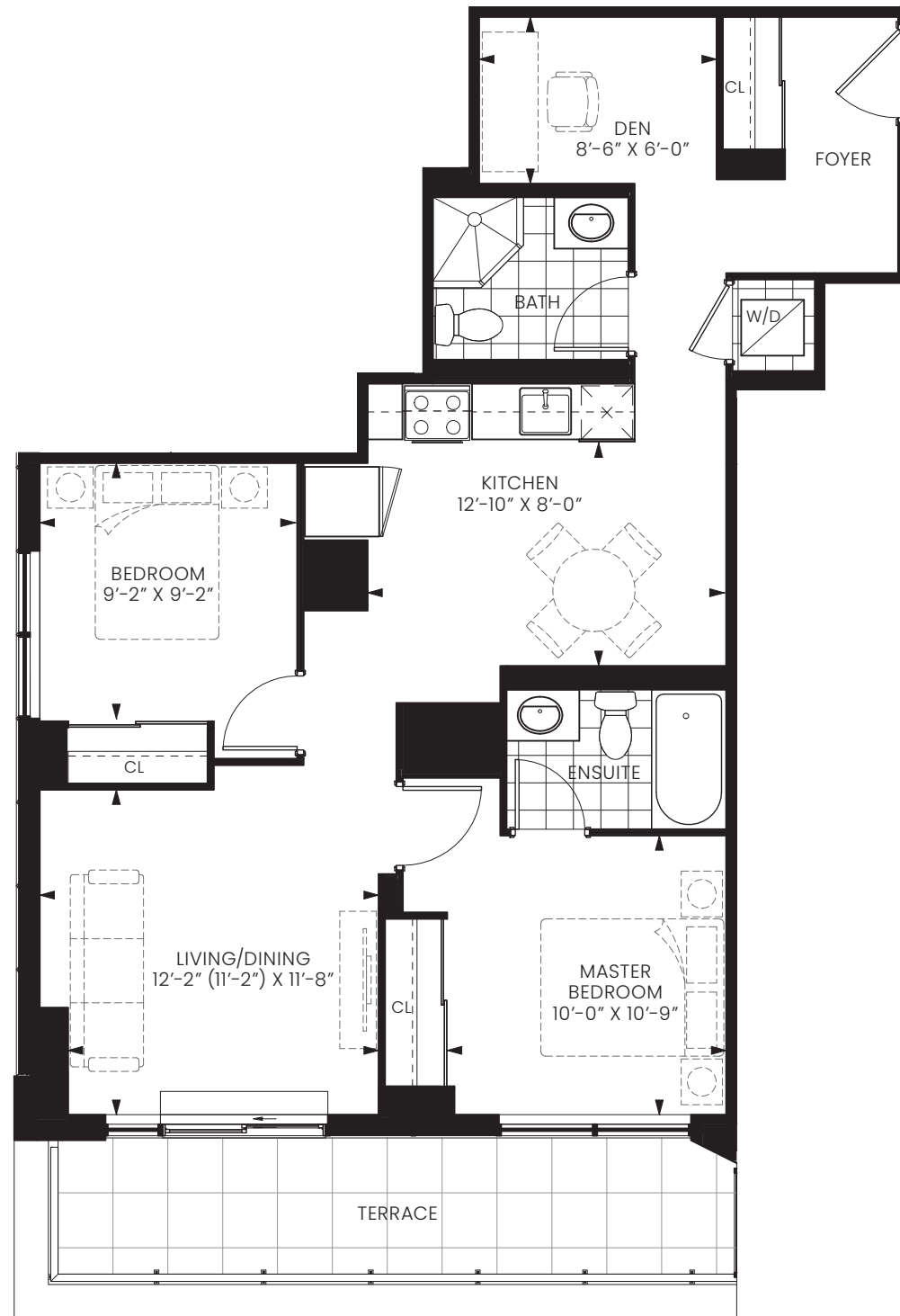

FLOOR 4

Note: All prices, figures, sizes, specifications and information, including without limitation the size, location, design and layout of windows, doors, walls, fixtures, closets, structures, appliances (if any), and the balcony are subject to change without notice to the Purchaser in order to comply with site conditions, municipal or governmental, structural, or architectural requirements, or for any reason at the discretion of the Vendor. Units on lower floors may have less floor space due to thicker structural members, mechanical rooms, etc. while units on higher floors may have more floor space. Bulkheads may not be shown on this plan and may be located in areas of the Unit as required for venting and mechanical systems. All areas and stated dimensions are approximate. Actual usable floor space, living area and square footage may vary from stated floor area. All illustrations are artist's concept only. Furniture is depicted for illustration purposes only & are not included. The unit shown may be the reverse of the unit purchased. The exact location of any balcony (if applicable) in relation to the unit layout may differ from that shown. E & O.E.



**CHESTNUT HILL
DEVELOPMENTS**

BUILDING COMMUNITIES SINCE 1981

SUITE 2B+D

TWO BEDROOM + DEN

INTERIOR 916 SQ. FT. | EXTERIOR 266 SQ. FT. | TOTAL 1,182 SQ. FT.

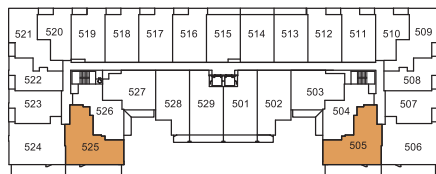

FLOOR 5

Note: All prices, figures, sizes, specifications and information, including without limitation the size, location, design and layout of windows, doors, walls, fixtures, closets, structures, appliances (if any), and the balcony are subject to change without notice to the Purchaser in order to comply with site conditions, municipal or governmental, structural, or architectural requirements, or for any reason at the discretion of the Vendor. Units on lower floors may have less floor space due to thicker structural members, mechanical rooms, etc. while units on higher floors may have more floor space. Bulkheads may not be shown on this plan and may be located in areas of the Unit as required for venting and mechanical systems. All areas and stated dimensions are approximate. Actual usable floor space, living area and square footage may vary from stated floor area. All illustrations are artist's concept only. Furniture is depicted for illustration purposes only & are not included. The unit shown may be the reverse of the unit purchased. The exact location of any balcony (if applicable) in relation to the unit layout may differ from that shown. E & O.E.



**CHESTNUT HILL
DEVELOPMENTS**

BUILDING COMMUNITIES SINCE 1981

SUITE 2D+D

TWO BEDROOM + DEN

INTERIOR 974 SQ. FT. | EXTERIOR 267 SQ. FT. | TOTAL 1,241 SQ. FT.

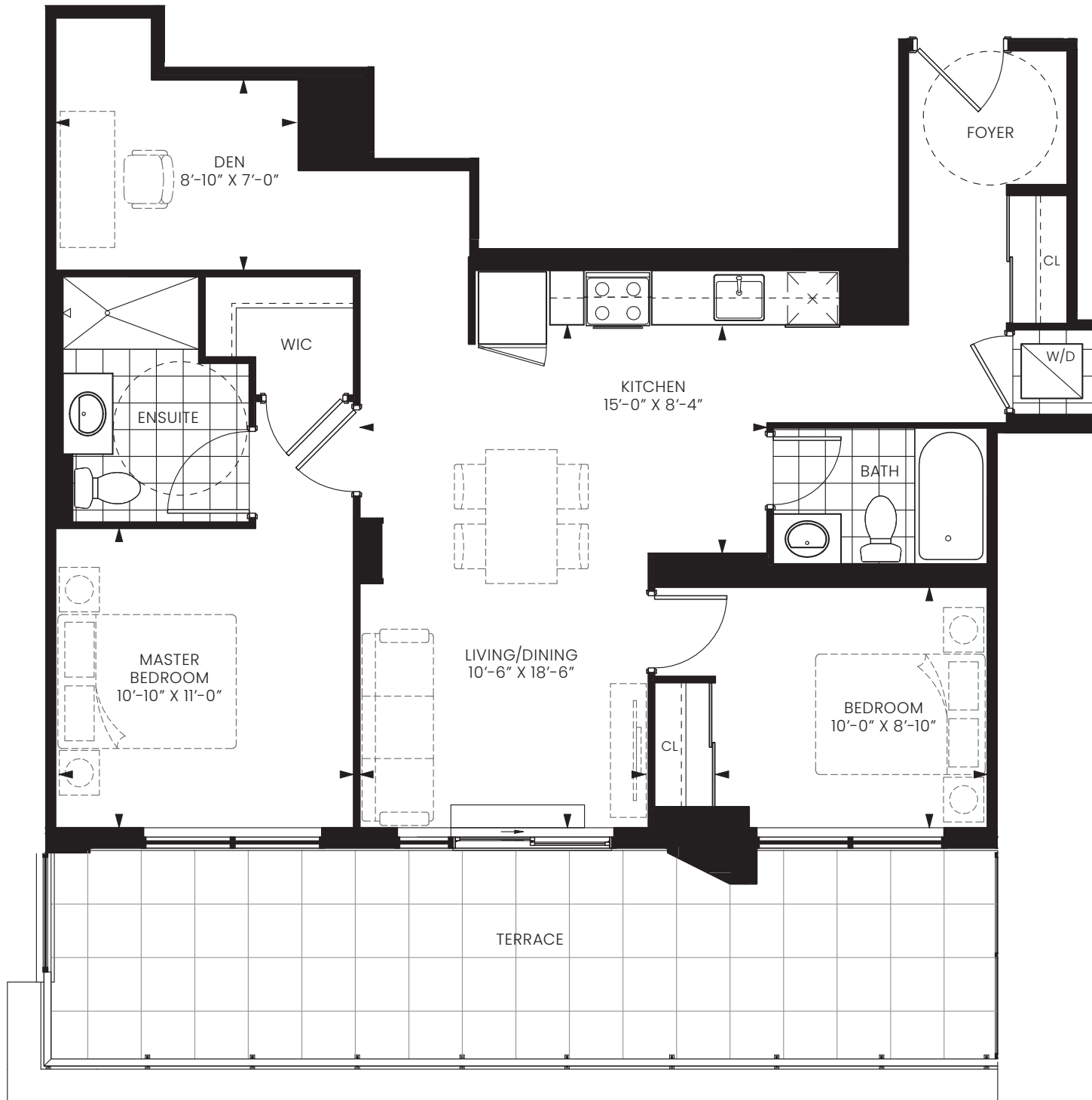

FLOOR 8

Note: All prices, figures, sizes, specifications and information, including without limitation the size, location, design and layout of windows, doors, walls, fixtures, closets, structures, appliances (if any), and the balcony are subject to change without notice to the Purchaser in order to comply with site conditions, municipal or governmental, structural, or architectural requirements, or for any reason at the discretion of the Vendor. Units on lower floors may have less floor space due to thicker structural members, mechanical rooms, etc. while units on higher floors may have more floor space. Bulkheads may not be shown on this plan and may be located in areas of the Unit as required for venting and mechanical systems. All areas and stated dimensions are approximate. Actual usable floor space, living area and square footage may vary from stated floor area. All illustrations are artist's concept only. Furniture is depicted for illustration purposes only & are not included. The unit shown may be the reverse of the unit purchased. The exact location of any balcony (if applicable) in relation to the unit layout may differ from that shown. E & O.E.



**CHESTNUT HILL
DEVELOPMENTS**

BUILDING COMMUNITIES SINCE 1981

SUITE 2E + D

TWO BEDROOM + DEN

INTERIOR 936 SQ. FT. | EXTERIOR 267 SQ. FT. | TOTAL 1,203 SQ. FT.



FLOOR 8

Note: All prices, figures, sizes, specifications and information, including without limitation the size, location, design and layout of windows, doors, walls, fixtures, closets, structures, appliances (if any), and the balcony are subject to change without notice to the Purchaser in order to comply with site conditions, municipal or governmental, structural, or architectural requirements, or for any reason at the discretion of the Vendor. Units on lower floors may have less floor space due to thicker structural members, mechanical rooms, etc. while units on higher floors may have more floor space. Bulkheads may not be shown on this plan and may be located in areas of the Unit as required for venting and mechanical systems. All areas and stated dimensions are approximate. Actual usable floor space, living area and square footage may vary from stated floor area. All illustrations are artist's concept only. Furniture is depicted for illustration purposes only & are not included. The unit shown may be the reverse of the unit purchased. The exact location of any balcony (if applicable) in relation to the unit layout may differ from that shown. E & O.E.



**CHESTNUT HILL
DEVELOPMENTS**

BUILDING COMMUNITIES SINCE 1981

SUITE 2F+D

TWO BEDROOM + DEN

INTERIOR 917 SQ. FT. | EXTERIOR 94 SQ. FT. | TOTAL 1,011 SQ. FT.

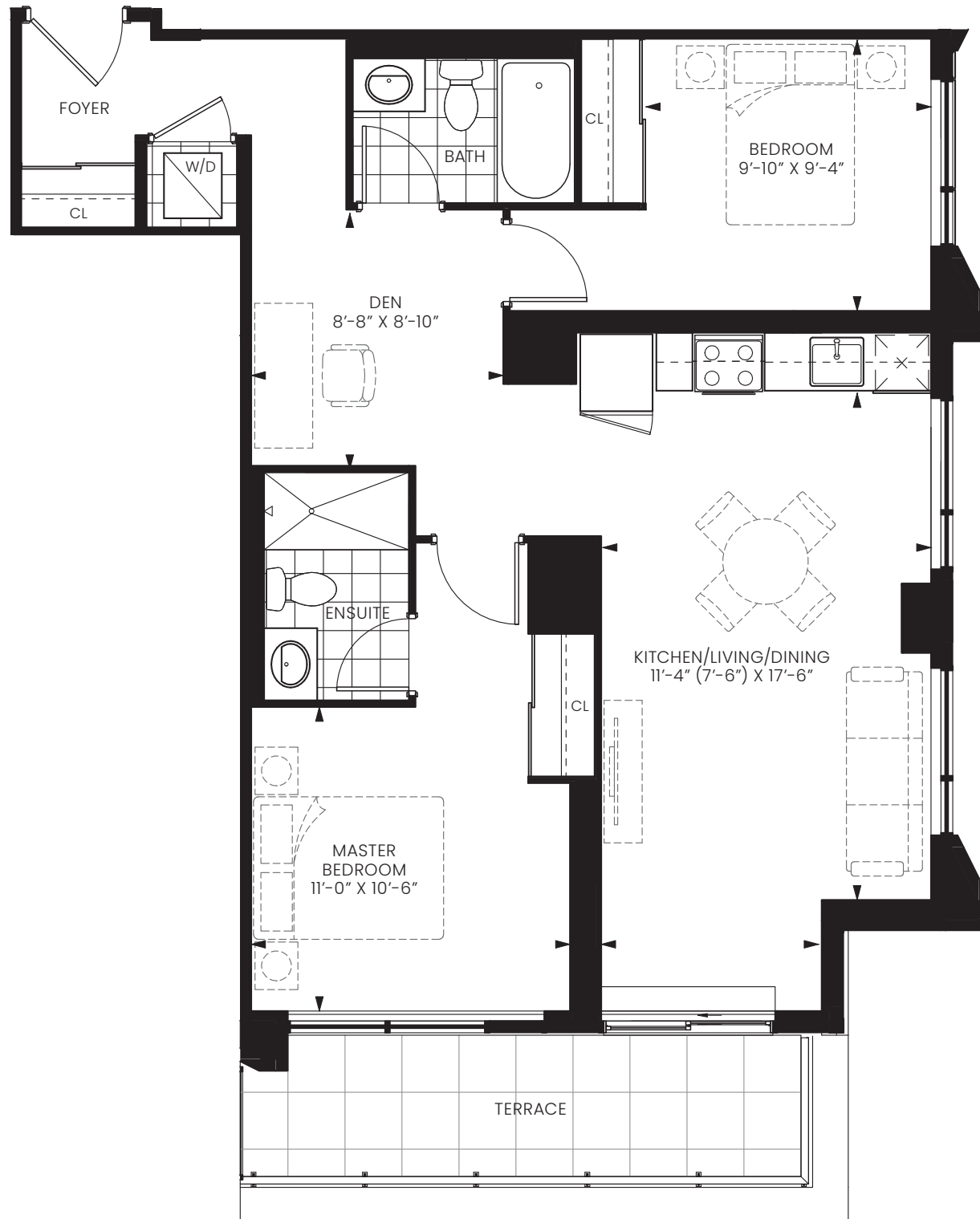

FLOOR 4

Note: All prices, figures, sizes, specifications and information, including without limitation the size, location, design and layout of windows, doors, walls, fixtures, closets, structures, appliances (if any), and the balcony are subject to change without notice to the Purchaser in order to comply with site conditions, municipal or governmental, structural, or architectural requirements, or for any reason at the discretion of the Vendor. Units on lower floors may have less floor space due to thicker structural members, mechanical rooms, etc. while units on higher floors may have more floor space. Bulkheads may not be shown on this plan and may be located in areas of the Unit as required for venting and mechanical systems. All areas and stated dimensions are approximate. Actual usable floor space, living area and square footage may vary from stated floor area. All illustrations are artist's concept only. Furniture is depicted for illustration purposes only & are not included. The unit shown may be the reverse of the unit purchased. The exact location of any balcony (if applicable) in relation to the unit layout may differ from that shown. E & O.E.



**CHESTNUT HILL
DEVELOPMENTS**

BUILDING COMMUNITIES SINCE 1981

SUITE 2G+D

TWO BEDROOM + DEN

INTERIOR 843 SQ. FT. | EXTERIOR 642 SQ. FT. | TOTAL 1,485 SQ. FT.

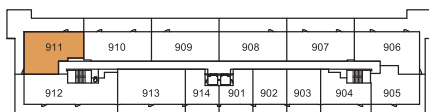
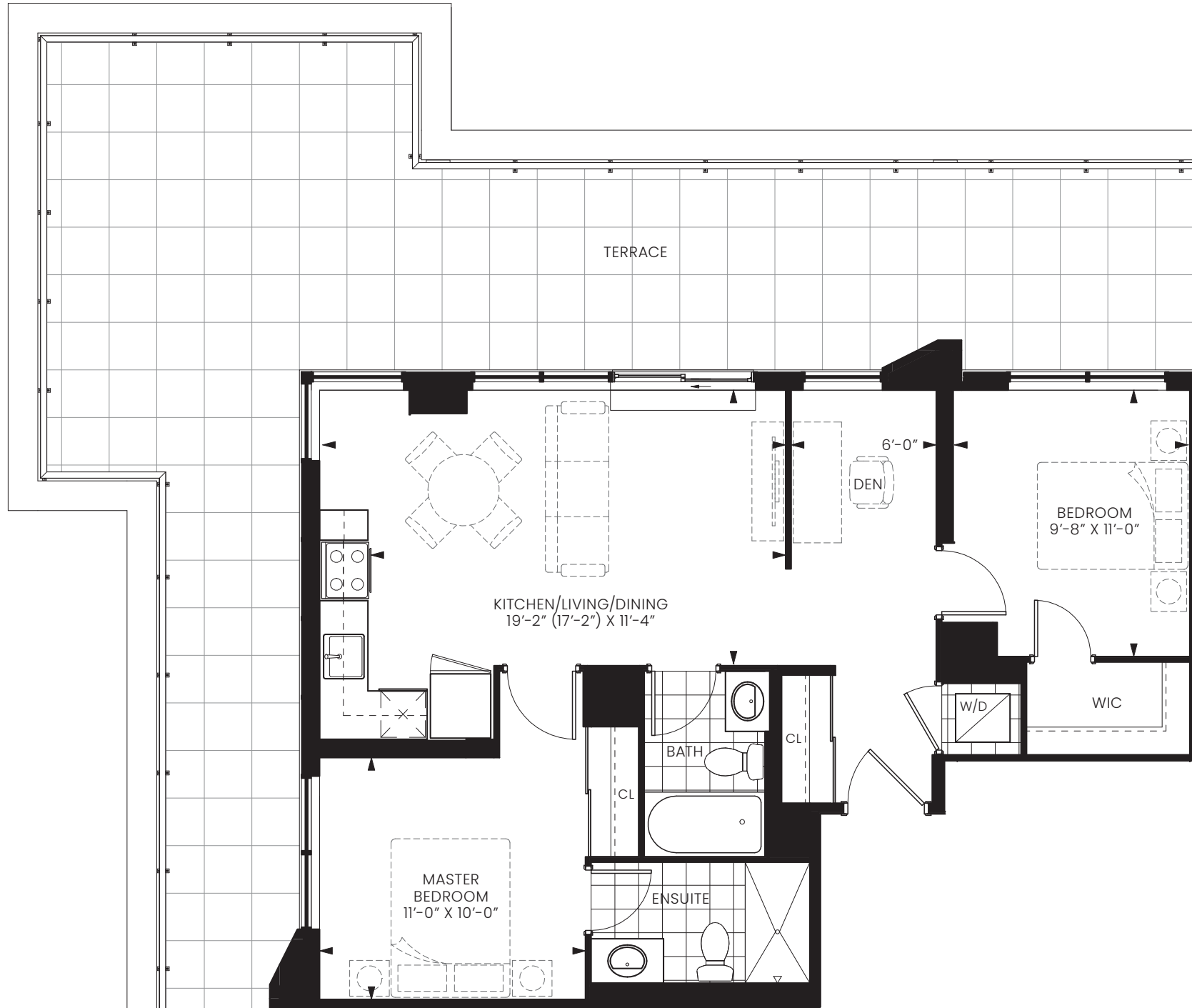

FLOOR 9

Note: All prices, figures, sizes, specifications and information, including without limitation the size, location, design and layout of windows, doors, walls, fixtures, closets, structures, appliances (if any), and the balcony are subject to change without notice to the Purchaser in order to comply with site conditions, municipal or governmental, structural, or architectural requirements, or for any reason at the discretion of the Vendor. Units on lower floors may have less floor space due to thicker structural members, mechanical rooms, etc. while units on higher floors may have more floor space. Bulkheads may not be shown on this plan and may be located in areas of the Unit as required for venting and mechanical systems. All areas and stated dimensions are approximate. Actual usable floor space, living area and square footage may vary from stated floor area. All illustrations are artist's concept only. Furniture is depicted for illustration purposes only & are not included. The unit shown may be the reverse of the unit purchased. The exact location of any balcony (if applicable) in relation to the unit layout may differ from that shown. E & O.E.



**CHESTNUT HILL
DEVELOPMENTS**

BUILDING COMMUNITIES SINCE 1981

SUITE 3A

THREE BEDROOM (LOFT)

INTERIOR 1,174 SQ. FT. | EXTERIOR 121 SQ. FT. | TOTAL 1,295 SQ. FT.

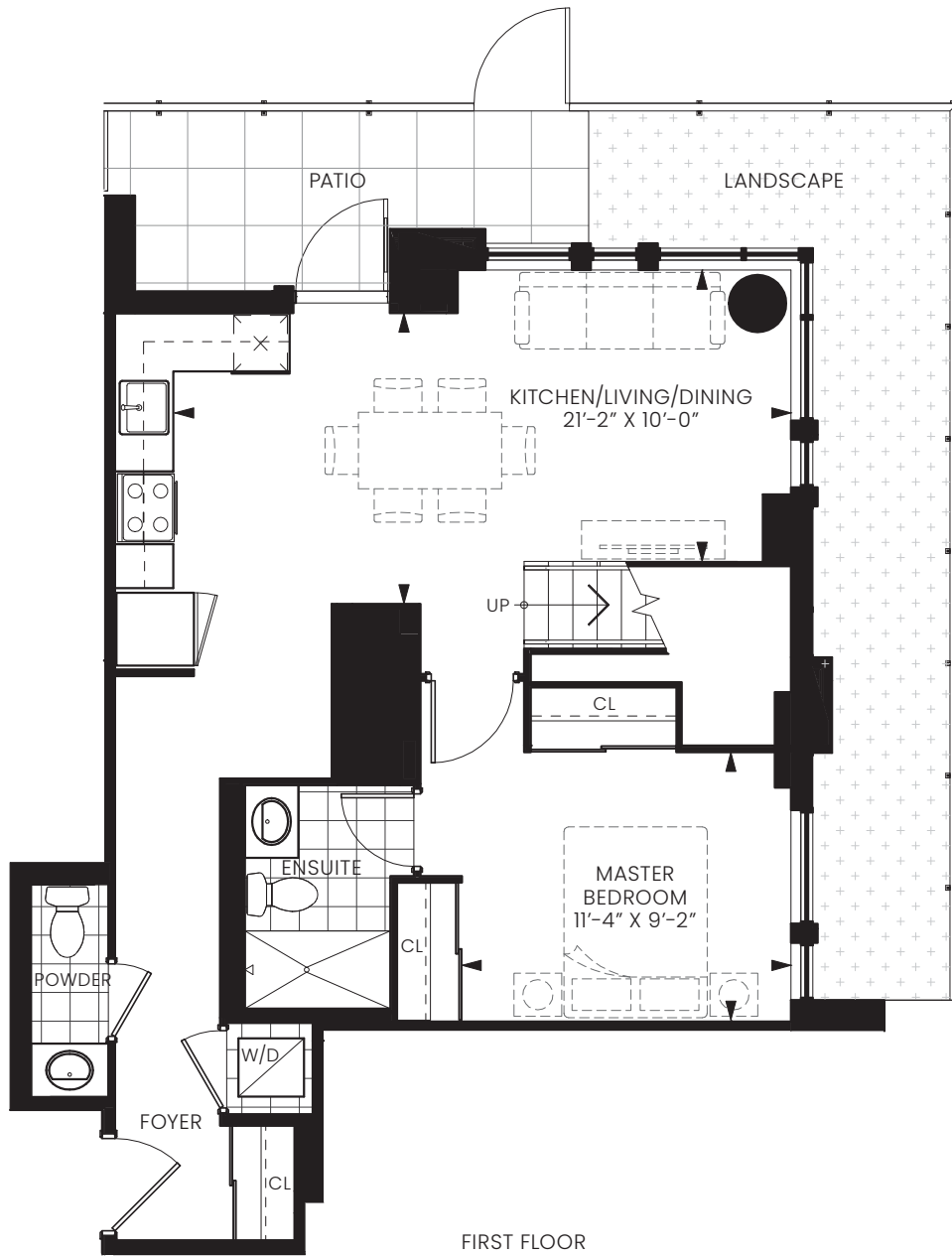

FIRST FLOOR

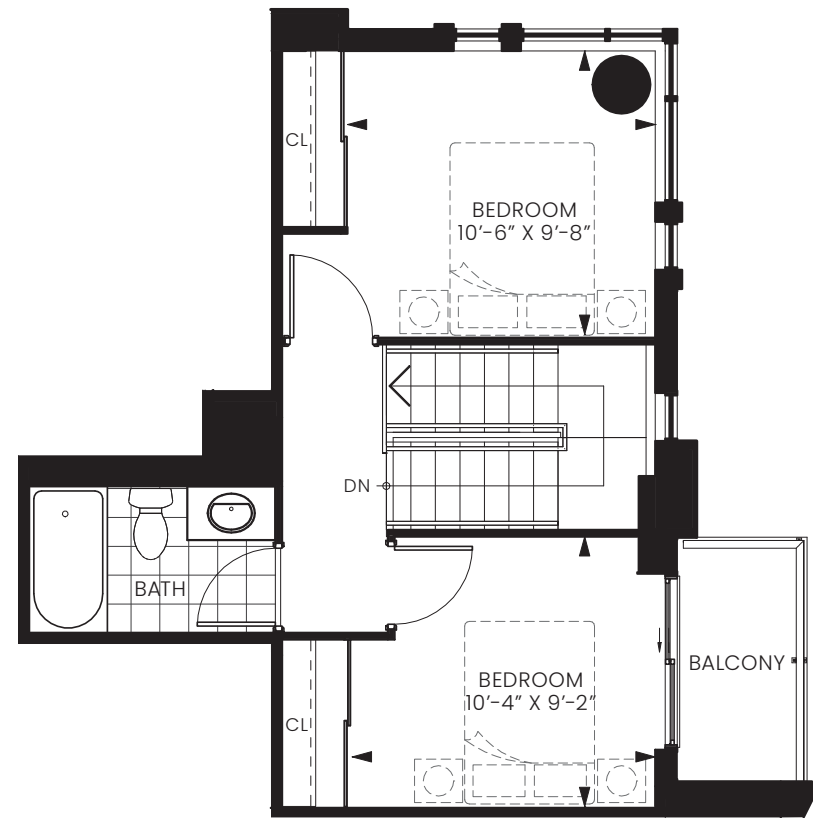

SECOND FLOOR

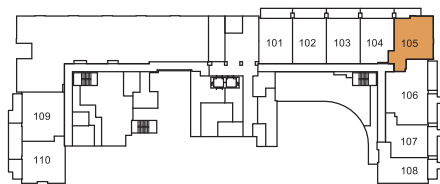

FLOOR 1

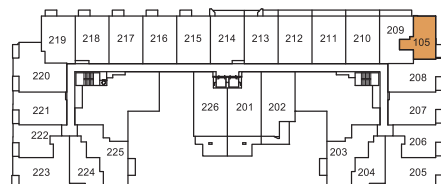

FLOOR 2

Note: All prices, figures, sizes, specifications and information, including without limitation the size, location, design and layout of windows, doors, walls, fixtures, closets, structures, appliances (if any), and the balcony are subject to change without notice to the Purchaser in order to comply with site conditions, municipal or governmental, structural, or architectural requirements, or for any reason at the discretion of the Vendor. Units on lower floors may have less floor space due to thicker structural members, mechanical rooms, etc. while units on higher floors may have more floor space. Bulkheads may not be shown on this plan and may be located in areas of the Unit as required for venting and mechanical systems. All areas and stated dimensions are approximate. Actual usable floor space, living area and square footage may vary from stated floor area. All illustrations are artist's concept only. Furniture is depicted for illustration purposes only & are not included. The unit shown may be the reverse of the unit purchased. The exact location of any balcony (if applicable) in relation to the unit layout may differ from that shown. E & O.E.



CHESTNUT HILL DEVELOPMENTS

BUILDING COMMUNITIES SINCE 1981

SUITE 3D

THREE BEDROOM

INTERIOR 931 SQ. FT. | EXTERIOR 258 SQ. FT. | TOTAL 1,189 SQ. FT.

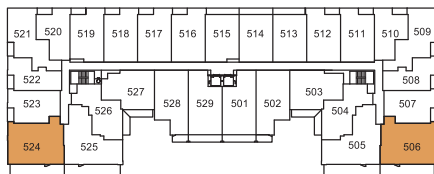
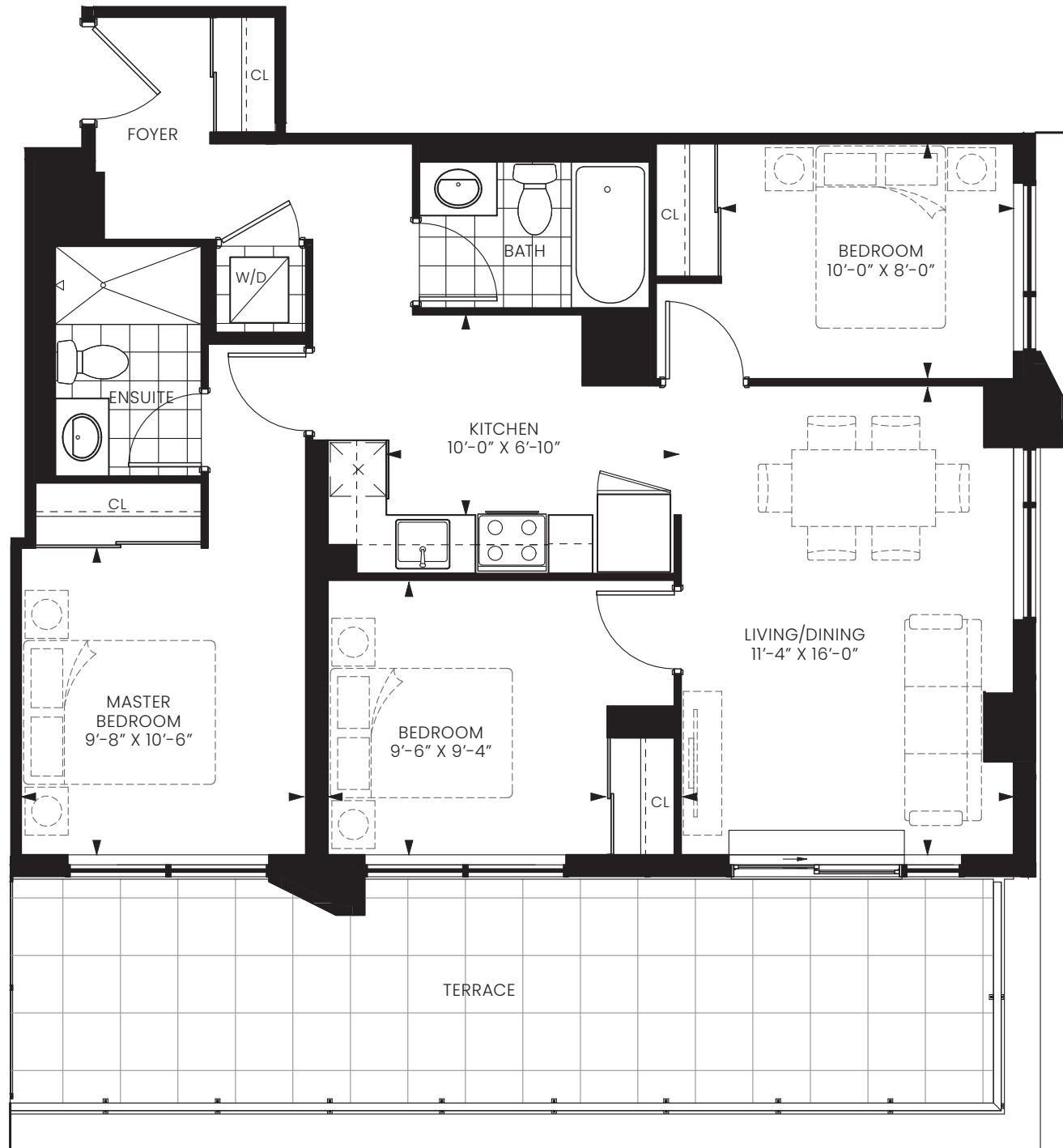

FLOOR 5

Note: All prices, figures, sizes, specifications and information, including without limitation the size, location, design and layout of windows, doors, walls, fixtures, closets, structures, appliances (if any), and the balcony are subject to change without notice to the Purchaser in order to comply with site conditions, municipal or governmental, structural, or architectural requirements, or for any reason at the discretion of the Vendor. Units on lower floors may have less floor space due to thicker structural members, mechanical rooms, etc. while units on higher floors may have more floor space. Bulkheads may not be shown on this plan and may be located in areas of the Unit as required for venting and mechanical systems. All areas and stated dimensions are approximate. Actual usable floor space, living area and square footage may vary from stated floor area. All illustrations are artist's concept only. Furniture is depicted for illustration purposes only & are not included. The unit shown may be the reverse of the unit purchased. The exact location of any balcony (if applicable) in relation to the unit layout may differ from that shown. E & O.E.



**CHESTNUT HILL
DEVELOPMENTS**

BUILDING COMMUNITIES SINCE 1981

SUITE 3E

THREE BEDROOM

INTERIOR 1,113 SQ. FT. | EXTERIOR 177 SQ. FT. | TOTAL 1,290 SQ. FT.

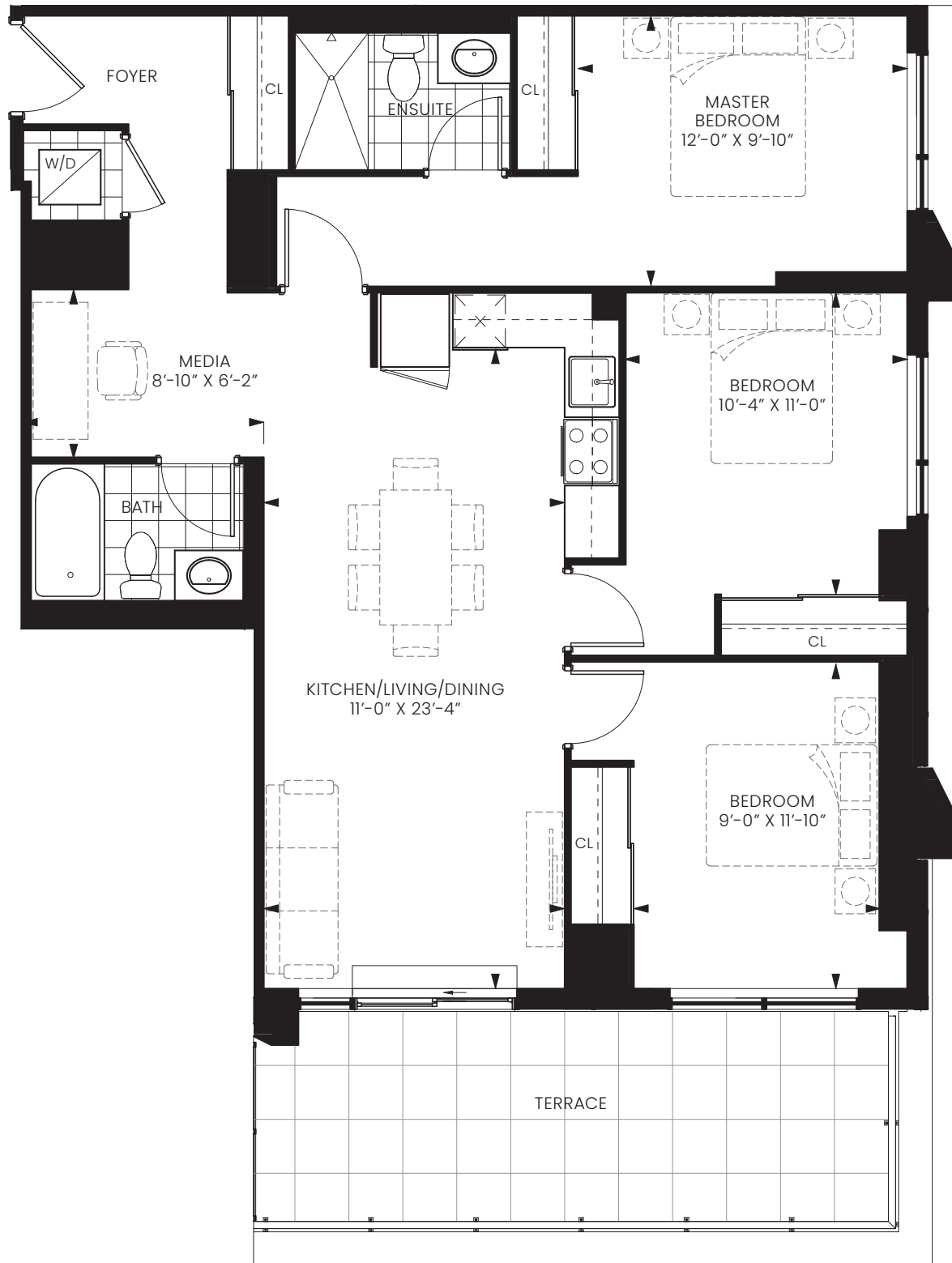

FLOOR 6

Note: All prices, figures, sizes, specifications and information, including without limitation the size, location, design and layout of windows, doors, walls, fixtures, closets, structures, appliances (if any), and the balcony are subject to change without notice to the Purchaser in order to comply with site conditions, municipal or governmental, structural, or architectural requirements, or for any reason at the discretion of the Vendor. Units on lower floors may have less floor space due to thicker structural members, mechanical rooms, etc. while units on higher floors may have more floor space. Bulkheads may not be shown on this plan and may be located in areas of the Unit as required for venting and mechanical systems. All areas and stated dimensions are approximate. Actual usable floor space, living area and square footage may vary from stated floor area. All illustrations are artist's concept only. Furniture is depicted for illustration purposes only & are not included. The unit shown may be the reverse of the unit purchased. The exact location of any balcony (if applicable) in relation to the unit layout may differ from that shown. E & O.E.



**CHESTNUT HILL
DEVELOPMENTS**

BUILDING COMMUNITIES SINCE 1981

SUITE 3G

THREE BEDROOM

INTERIOR 1,035 SQ. FT. | EXTERIOR 126 SQ. FT. | TOTAL 1,161 SQ. FT.

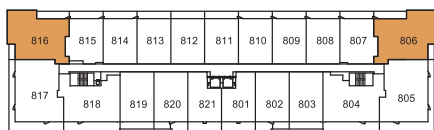
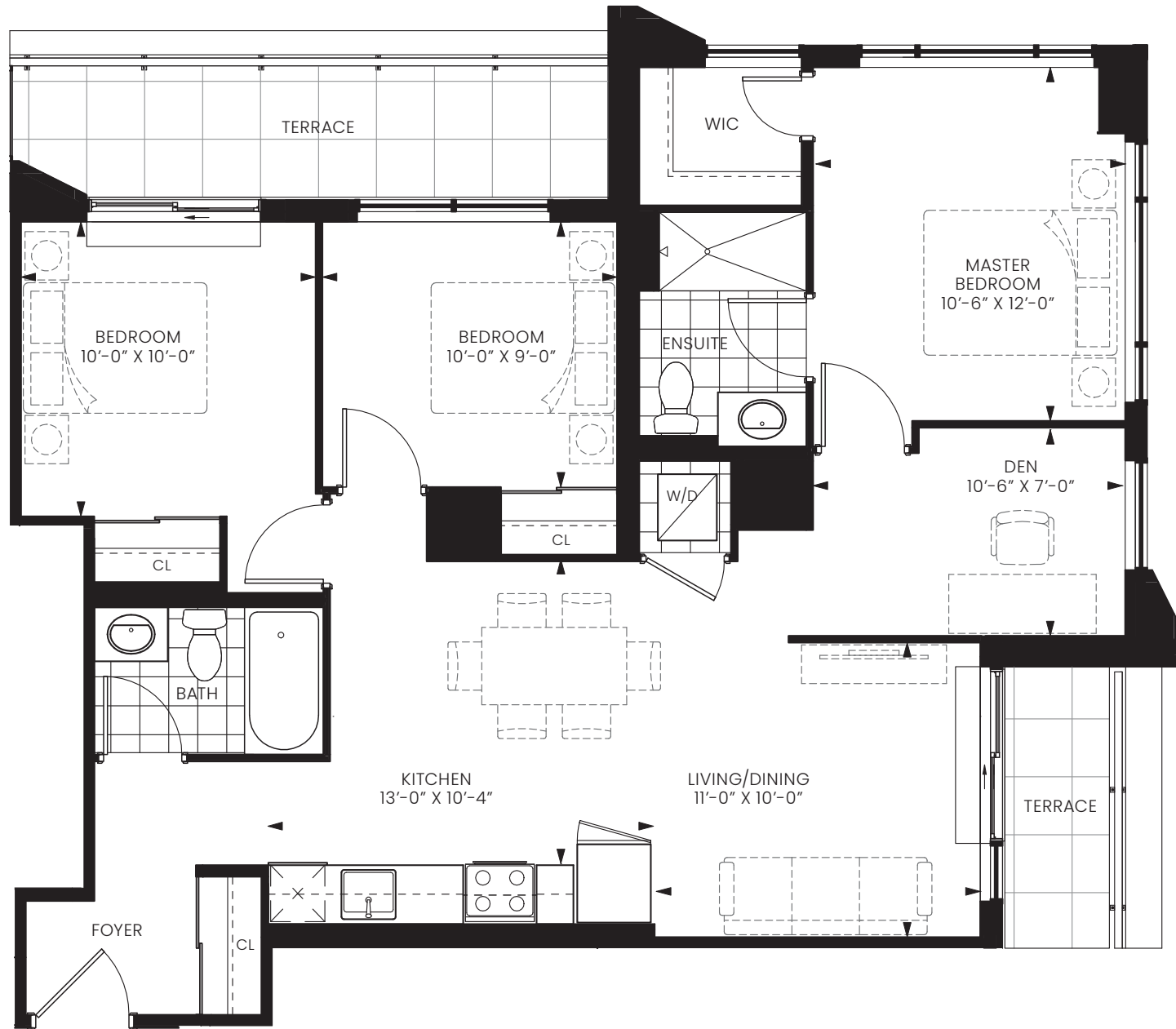

FLOOR 8

Note: All prices, figures, sizes, specifications and information, including without limitation the size, location, design and layout of windows, doors, walls, fixtures, closets, structures, appliances (if any), and the balcony are subject to change without notice to the Purchaser in order to comply with site conditions, municipal or governmental, structural, or architectural requirements, or for any reason at the discretion of the Vendor. Units on lower floors may have less floor space due to thicker structural members, mechanical rooms, etc. while units on higher floors may have more floor space. Bulkheads may not be shown on this plan and may be located in areas of the Unit as required for venting and mechanical systems. All areas and stated dimensions are approximate. Actual usable floor space, living area and square footage may vary from stated floor area. All illustrations are artist's concept only. Furniture is depicted for illustration purposes only & are not included. The unit shown may be the reverse of the unit purchased. The exact location of any balcony (if applicable) in relation to the unit layout may differ from that shown. E & O.E.



**CHESTNUT HILL
DEVELOPMENTS**

BUILDING COMMUNITIES SINCE 1981

SUITE 3L

THREE BEDROOM

INTERIOR 993 SQ. FT. | EXTERIOR 592 SQ. FT. | TOTAL 1,585 SQ. FT.

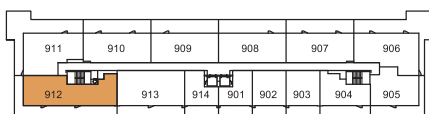
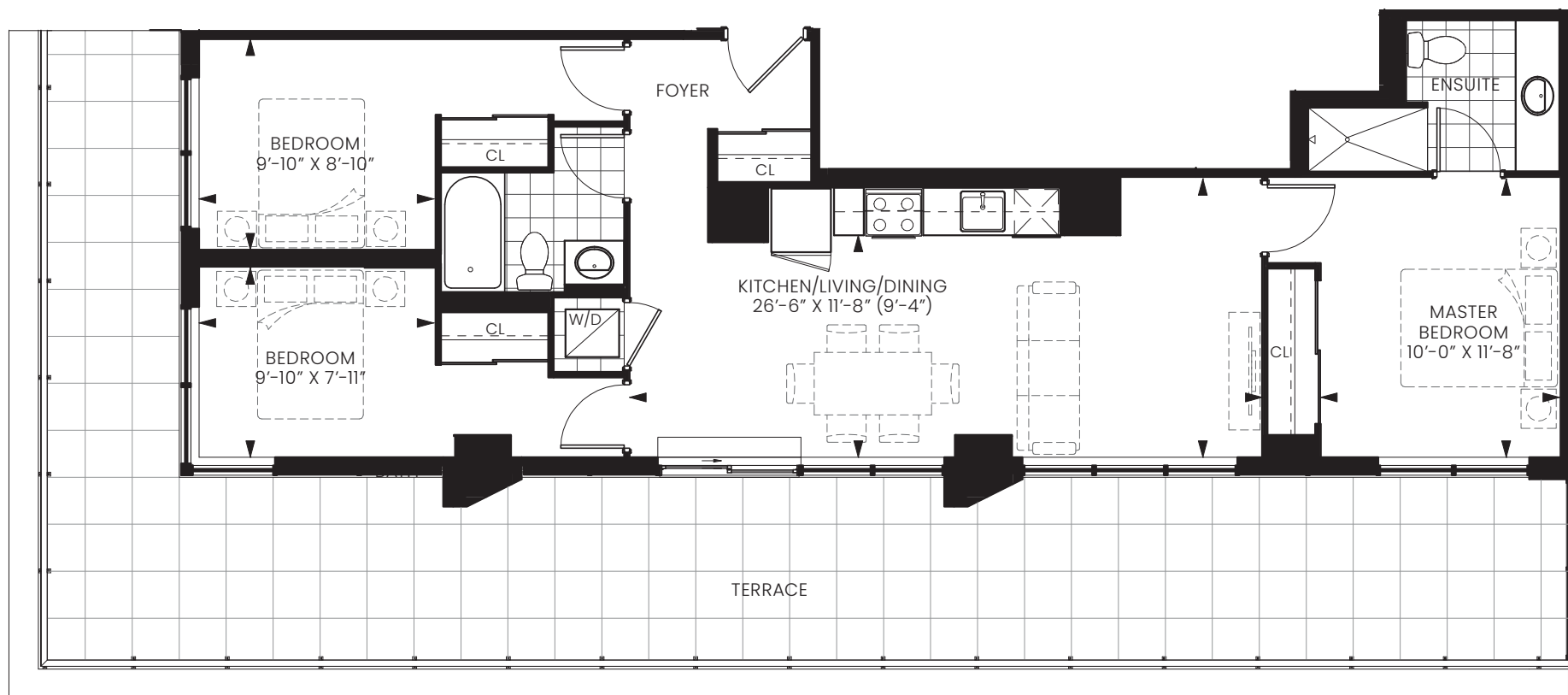

FLOOR 9

Note: All prices, figures, sizes, specifications and information, including without limitation the size, location, design and layout of windows, doors, walls, fixtures, closets, structures, appliances (if any), and the balcony are subject to change without notice to the Purchaser in order to comply with site conditions, municipal or governmental, structural, or architectural requirements, or for any reason at the discretion of the Vendor. Units on lower floors may have less floor space due to thicker structural members, mechanical rooms, etc. while units on higher floors may have more floor space. Bulkheads may not be shown on this plan and may be located in areas of the Unit as required for venting and mechanical systems. All areas and stated dimensions are approximate. Actual usable floor space, living area and square footage may vary from stated floor area. All illustrations are artist's concept only. Furniture is depicted for illustration purposes only & are not included. The unit shown may be the reverse of the unit purchased. The exact location of any balcony (if applicable) in relation to the unit layout may differ from that shown. E & O.E.



**CHESTNUT HILL
DEVELOPMENTS**

BUILDING COMMUNITIES SINCE 1981

SUITE 3M

THREE BEDROOM

INTERIOR 925 SQ. FT. | EXTERIOR 320 SQ. FT. | TOTAL 1,245 SQ. FT.

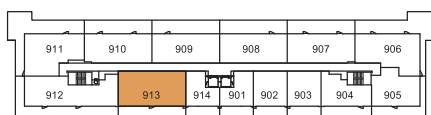
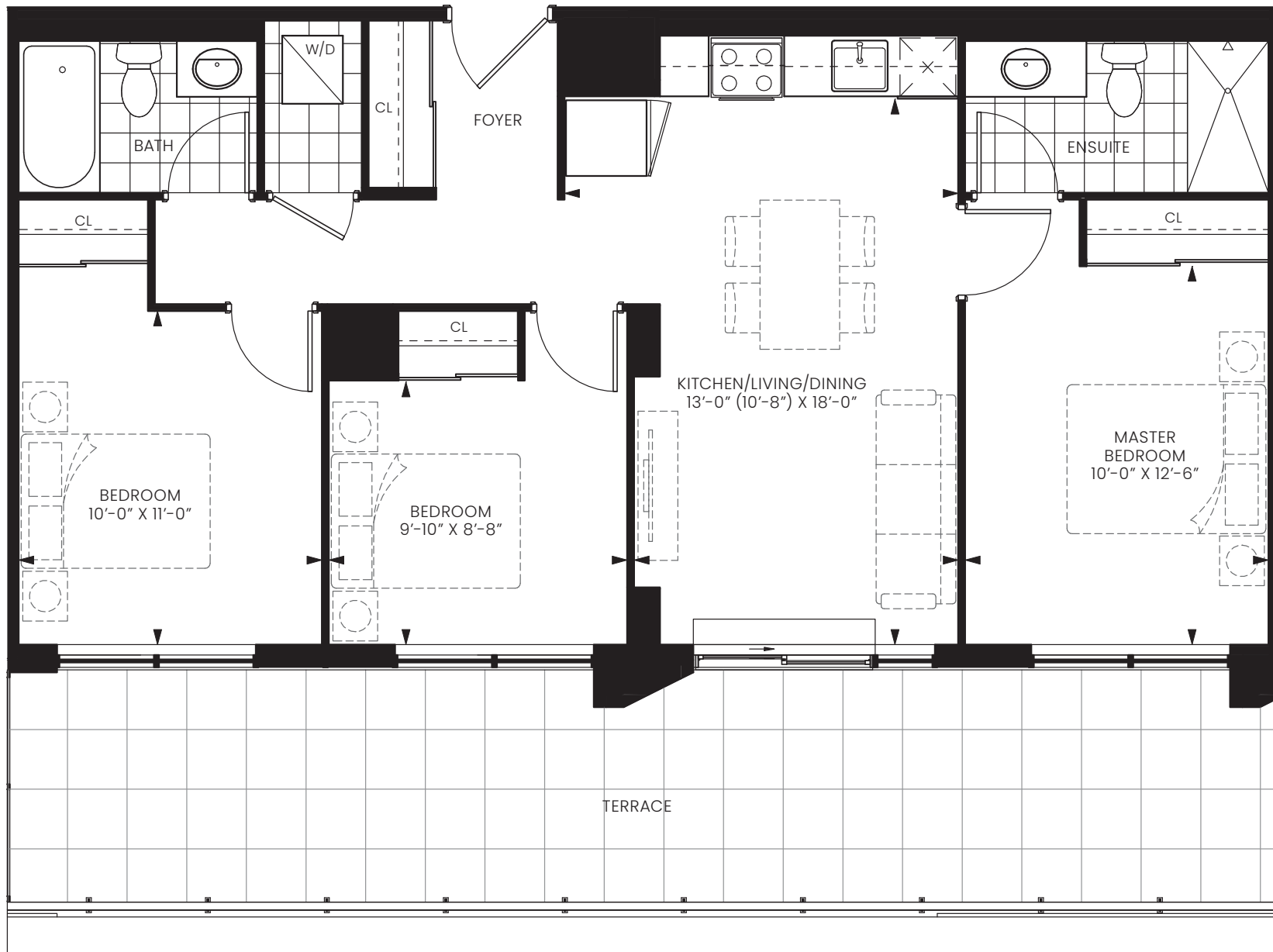

FLOOR 9

Note: All prices, figures, sizes, specifications and information, including without limitation the size, location, design and layout of windows, doors, walls, fixtures, closets, structures, appliances (if any), and the balcony are subject to change without notice to the Purchaser in order to comply with site conditions, municipal or governmental, structural, or architectural requirements, or for any reason at the discretion of the Vendor. Units on lower floors may have less floor space due to thicker structural members, mechanical rooms, etc. while units on higher floors may have more floor space. Bulkheads may not be shown on this plan and may be located in areas of the Unit as required for venting and mechanical systems. All areas and stated dimensions are approximate. Actual usable floor space, living area and square footage may vary from stated floor area. All illustrations are artist's concept only. Furniture is depicted for illustration purposes only & are not included. The unit shown may be the reverse of the unit purchased. The exact location of any balcony (if applicable) in relation to the unit layout may differ from that shown. E & O.E.



**CHESTNUT HILL
DEVELOPMENTS**

BUILDING COMMUNITIES SINCE 1981